

boogaloo

sillas • mesas • mesas de centro • butacas • sofás • salones • literas



bogal bogal bogal bogal

sillas

pág. 09

mesas

pág. 87

mesas  
de centro

pág. 133

butacas

pág. 157

sofás

pág. 173

salones

pág. 179

literas

pág. 193

bogal

Naturalmente versátil

Una colección inspirada en el mundo, con diseños funcionales para todos los gustos, clásicos, modernos, contemporáneos y eclécticos, que se adaptan a cualquier estilo y te harán sentir en armonía con tu hogar. Una gama de interior y exterior que combina formas, colores, texturas y materiales.

Renueva el ambiente añadiendo toques de color a las sillas. Crea momentos únicos alrededor de una mesa con tu familia. Aprovecha la opción extensible para las celebraciones con amigos. Relájate en tu tiempo de descanso con un buen sofá. Échate las mejores siestas en nuestras butacas. Disfruta de tu particular paraíso al aire libre con nuestras piezas de exterior.

No te pierdas todos los artículos que te presentamos.

# sillas



silla ATLANTA 10



silla OSLO 12



silla ANKARA 14



silla ESTAMBUL 16



silla PARÍS 17



silla LISBOA 18



silla BEIRUT 20



silla BERGEN 22



silla SEÚL 24



silla HANOI 26



silla OSAKA 27



silla QUEBEC 28



silla SIDNEY 30



silla DALLAS 32



silla DENVER 34



silla VENEZIA 36



silla MEMPHIS 38



silla AUSTIN 39



silla NIZA 40



silla ZAGREB 42



silla SICILIA 44



silla NÁPOLES 45



silla CHICAGO 46



silla DETROIT 47



silla CAIRO 48



silla VIENA 49



silla BOMBAY 50



silla OPORTO 51



silla DUBAI 52



silla SOFÍA 53



silla BERLÍN 54



silla AMSTERDAM 55



silla VEGAS 56



silla MÚNICH 57



silla MIAMI 58



silla LONDON 60



silla DUBLÍN 61



silla ORLANDO 62



silla BERNA 64



silla PISA 65



silla ROMA 66



silla MILÁN 67



silla LAGOS 68



silla PRAGA 69



silla BOGOTA 70



silla HABANA 72



silla ATENAS 74



silla VALETA 76



silla CUZCO 78



taburete VISBY 79



silla BREMEN 80



silla BUCAREST 82



silla KIEV 83



silla SAMARA 84



silla SOCHI 85

# mesas



# mesas de centro



# butacas



# sofás



sofá  
**ZOE**  
MANUAL / ELÉCTRICO GRIS

174



sofá  
**ZOE**  
MANUAL / ELÉCTRICO PIZARRA

176

# salones



salón  
**SAMURAI**  
BAJO TV 2p. 120

185



mesa  
**PERSICO**  
RECTANGULAR

186



juego mesas auxiliares  
**JAVA**  
CUADRADAS

188



juego mesas auxiliares  
**JAVA**  
REDONDAS

189



mesa centro  
**JAVA**  
CUADRADA

190



mesa centro  
**JAVA**  
RECTANGULAR

191



salón  
**SAMURAI**  
BAR 80

184



salón  
**SAMURAI**  
BAJO TV 2p. 2c. 160

184



salón  
**SAMURAI**  
BAJO TV 3p. 180

185

# literas



litera  
**TERUEL**  
90 - 90

194



litera  
**BILBAO**  
90 - 135

196

sillas

mesas

mesas de centro

butacas

sofás

salones

literas

bogal

sillas

# Atlanta

Silla con asiento y respaldo tapizados. Patas de metal negras.

PUNTOS	50 x 4 UNIDADES = <b>200</b>
SILLAS POR CAJA	4
PESO POR CAJA	26 kg



**CG1540VE**  
Silla ATLANTA verde 77



**CG1540SA**  
Silla ATLANTA salmón 52



**CG1540GR**  
Silla ATLANTA gris 10



**CG1540MO**  
Silla ATLANTA mostaza 68



**CG1540MA**  
Silla ATLANTA marrón 34



# Oslo

Silla con asiento y respaldo tapizados.  
Patas de metal negras.

PUNTOS	42 x 4 UNIDADES = <b>168</b>
SILLAS POR CAJA	4
PESO POR CAJA	21 kg



**CG1122GS**  
Silla OSLO gris 99



**CG1122BE**  
Silla OSLO beige



**CG1122PL**  
Silla OSLO plomo



**CG1122MU**  
Silla OSLO musgo



**CG1122MA**  
Silla OSLO marrón 34



**CG1122SA**  
Silla OSLO salmón 52



**CG1122MO**  
Silla OSLO mostaza 68



**CG1122VE**  
Silla OSLO verde 77



**CG1122AL**  
Silla OSLO azul 83



**CG1122GR**  
Silla OSLO gris 10



# Ankara

Silla con asiento y respaldo tapizados. Patas de metal negras.



**CG1510CR**  
Silla ANKARA  
crema



PUNTOS	72 x 2 UNIDADES = <b>144</b>
SILLAS POR CAJA	2
PESO POR CAJA	12,3 kg



**CG1510GP**  
Silla ANKARA  
perla



**CG1510GM**  
Silla ANKARA  
marengo



**CG1510MA**  
Silla ANKARA  
marrón 34



**CG1510SA**  
Silla ANKARA  
salmón 52



**CG1510MO**  
Silla ANKARA  
mostaza 68



**CG1510VE**  
Silla ANKARA  
verde 77



**CG1510AL**  
Silla ANKARA  
azul 83



**CG1510GR**  
Silla ANKARA  
gris 10

# Estambul

Silla con asiento y respaldo tapizados. Patas de metal cromadas.

PUNTOS	72 x 2 UNIDADES = <b>144</b>
SILLAS POR CAJA	2
PESO POR CAJA	12,3 kg



**CG1508CR**  
Silla ESTAMBUL crema



**CG1508GP**  
Silla ESTAMBUL perla



**CG1508GM**  
Silla ESTAMBUL marengo



# París

Silla con asiento y respaldo tapizados en 4 acabados con patas de metal negras.

PUNTOS	64 x 4 UNIDADES = <b>256</b>
SILLAS POR CAJA	4
PESO POR CAJA	31 kg



**CG1118GS**  
Silla PARÍS gris 99



**CG1118BE**  
Silla PARÍS beige



**CG1118PL**  
Silla PARÍS plomo



**CG1118MU**  
Silla PARÍS musgo





# Lisboa

Silla con asiento y respaldo tapizados en 10 acabados con patas de metal negras.



PUNTOS	50 x 4 UNIDADES = <b>200</b>
SILLAS POR CAJA	4
PESO POR CAJA	22,5 kg



**CG1116GS**  
Silla LISBOA gris 99



**CG1116BE**  
Silla LISBOA beige



**CG1116PL**  
Silla LISBOA plomo



**CG1116MU**  
Silla LISBOA musgo



**CG1116MA**  
Silla LISBOA marrón 34



**CG1116SA**  
Silla LISBOA salmón 52



**CG1116MO**  
Silla LISBOA mostaza 68



**CG1116VE**  
Silla LISBOA verde 77



**CG1116AL**  
Silla LISBOA azul 53



**CG1116GR**  
Silla LISBOA gris 10

# Beirut

Silla con asiento y respaldo tapizados. Patas de metal negras.

PUNTOS	76 x 2 UNIDADES = <b>152</b>
SILLAS POR CAJA	2
PESO POR CAJA	18,8 kg



bogal



**CG1560MA**  
Silla BEIRUT  
marrón 34



**CG1560SA**  
Silla BEIRUT  
salmón 52



**CG1560MO**  
Silla BEIRUT  
mostaza 68



**CG1560VE**  
Silla BEIRUT  
verde 77



**CG1560AL**  
Silla BEIRUT  
azul 83



**CG1560GR**  
Silla BEIRUT  
gris 10



**CG1560NC**  
Silla BEIRUT  
nácar 25



# Bergen

Silla con asiento y respaldo tapizados. Patas de metal negras.

PUNTOS	74 x 2 UNIDADES = 148
SILLAS POR CAJA	2
PESO POR CAJA	12,5 kg



**CG1574MA**  
Silla BERGEN  
marrón 34



**CG1574SA**  
Silla BERGEN  
salmón 52



**CG1574MO**  
Silla BERGEN  
mostaza 68



**CG1574VE**  
Silla BERGEN  
verde 77



**CG1574AL**  
Silla BERGEN  
azul 83



**CG1574GR**  
Silla BERGEN  
gris 10



**CG1574NC**  
Silla BERGEN  
nácar 25



# Seúl

Silla con asiento y respaldo tapizados. Patas de metal negras.

PUNTOS 46 x 4 UNIDADES = **184**

SILLAS POR CAJA 4

PESO POR CAJA 20,8 kg



**CG1572MO**  
Silla SEÚL  
mostaza 68

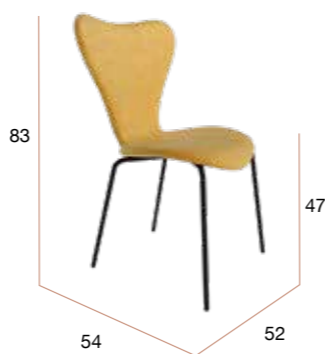

**CG1572VE**  
Silla SEÚL  
verde 77



**CG1572GR**  
Silla SEÚL  
gris 10





**CG1570SA**  
Silla HANOI  
salmón 52



**CG1570MO**  
Silla HANOI  
mostaza 68

# Hanoi

Silla con asiento y respaldo tapizados. Patas de metal negras.

PUNTOS	52 x 4 UNIDADES = <b>208</b>
SILLAS POR CAJA	4
PESO POR CAJA	19,6 kg

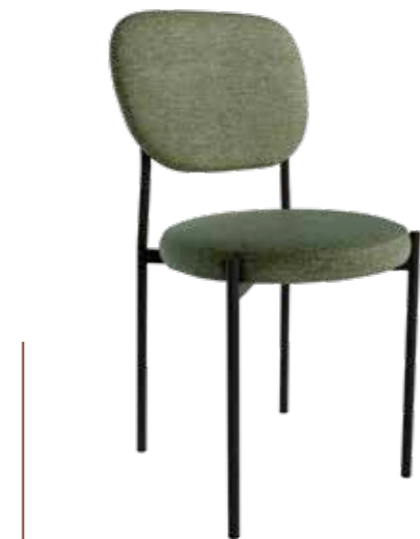

**CG1570VE**  
Silla HANOI  
verde 77



**CG1570AL**  
Silla HANOI  
azul 83

# Osaka

Silla con asiento y respaldo tapizados. Patas de metal negras.

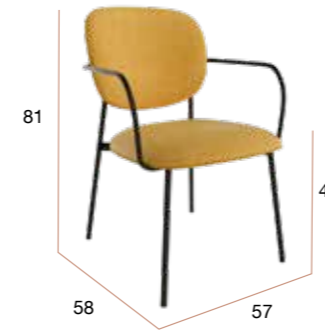

PUNTOS	68 x 2 UNIDADES = <b>136</b>
SILLAS POR CAJA	2
PESO POR CAJA	15,3 kg



**CG1562MO**  
Silla OSAKA  
mostaza 68



**CG1562VE**  
Silla OSAKA  
verde 77



**CG1562GR**  
Silla OSAKA  
gris 10







# Quebec

Silla con asiento y respaldo tapizados. Patas de metal negras.

PUNTOS	88
SILLAS POR CAJA	1
PESO POR CAJA	9,1 kg

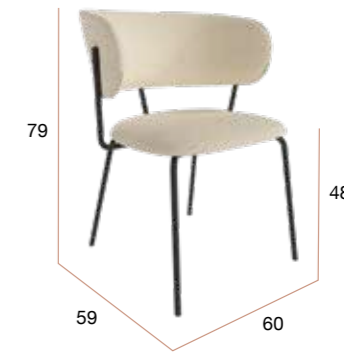

**CG1564SA**  
Silla QUEBEC  
salmón 52



**CG1564MO**  
Silla QUEBEC  
mostaza 68



**CG1564VE**  
Silla QUEBEC  
verde 77



**CG1564GR**  
Silla QUEBEC  
gris 10



**CG1564LA**  
Silla QUEBEC  
lamb

# Sidney

Silla con asiento y respaldo tapizados. Patas de metal negras.



PUNTOS	96
SILLAS POR CAJA	1
PESO POR CAJA	10,2 kg



**CG1566MO**  
Silla SIDNEY  
mostaza 68



**CG1566VE**  
Silla SIDNEY  
verde 77



**CG1566AL**  
Silla SIDNEY  
azul 83



**CG1566NC**  
Silla SIDNEY  
nacar 25



# Dallas

Silla con asiento y respaldo tapizados. Patas de metal negras.

PUNTOS	42 x 4 UNIDADES = <b>168</b>
SILLAS POR CAJA	4
PESO POR CAJA	30 kg



**CG1544VE**  
Silla DALLAS verde 77



**CG1544SA**  
Silla DALLAS salmón 52



**CG1544GR**  
Silla DALLAS gris 10



**CG1544MO**  
Silla DALLAS mostaza 68



**CG1544MA**  
Silla DALLAS marrón 34





# Denver

Silla con asiento y respaldo tapizados. Patas de metal negras.

PUNTOS	50 x 4 UNIDADES = <b>200</b>
SILLAS POR CAJA	4
PESO POR CAJA	32 kg



**CG1542VE**  
Silla DENVER verde 77



**CG1542SA**  
Silla DENVER salmón 52



**CG1542GR**  
Silla DENVER gris 10



**CG1542MO**  
Silla DENVER mostaza 68



**CG1542MA**  
Silla DENVER marrón 34

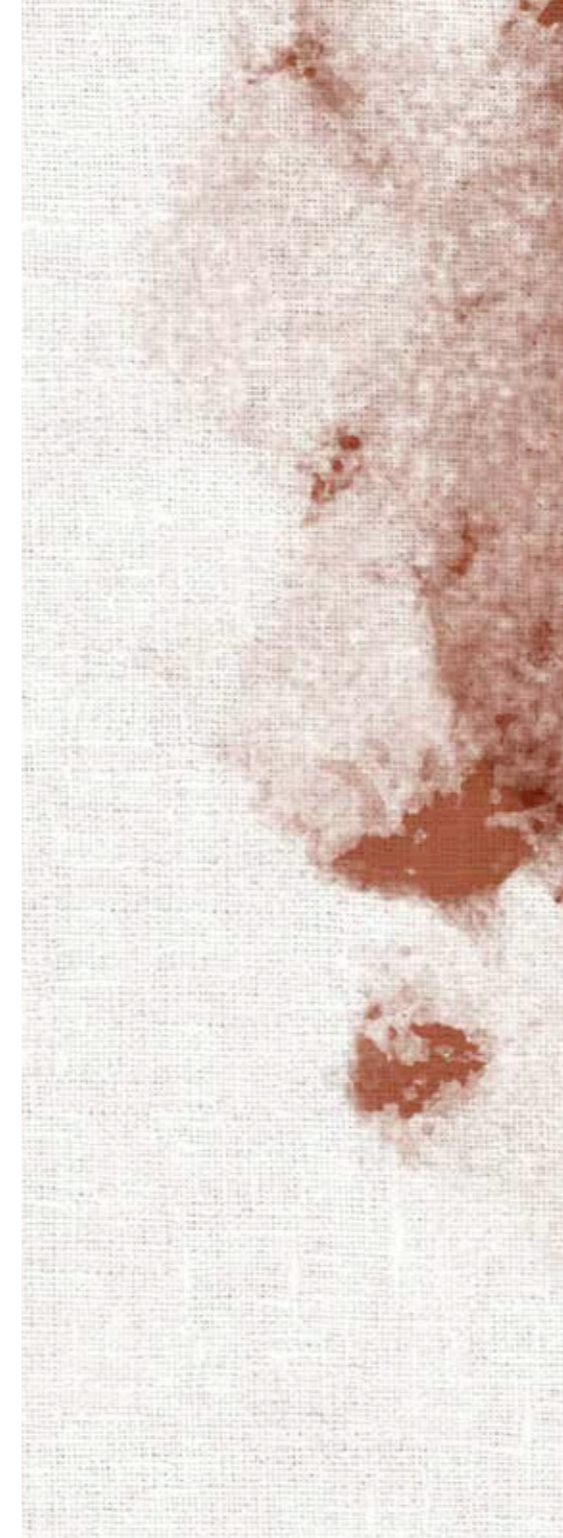

# Venecia

Silla con asiento y respaldo tapizados. Patas de metal negras.

PUNTOS	86 x 2 UNIDADES = <b>172</b>
SILLAS POR CAJA	2
PESO POR CAJA	17,5 kg



**CG1568MA**  
Silla VENECIA  
marrón 34



**CG1568MO**  
Silla VENECIA  
mostaza 68



**CG1568VE**  
Silla VENECIA  
verde 77



**CG1568GR**  
Silla VENECIA  
gris 10



**CG1568NC**  
Silla VENECIA  
nácar 25

# Memphis

Silla con asiento y respaldo tapizados.  
Patas de metal negras.

PUNTOS	54 x 4 UNIDADES = <b>216</b>
SILLAS POR CAJA	4
PESO POR CAJA	22,3 kg



**CG1550CR**  
Silla MEMPHIS crema



**CG1550GP**  
Silla MEMPHIS perla



**CG1550GM**  
Silla MEMPHIS marengo



# Austin

Silla con asiento y respaldo tapizados. Patas de metal cromadas.

PUNTOS	54 x 4 UNIDADES = <b>216</b>
SILLAS POR CAJA	4
PESO POR CAJA	22,3 kg



**CG1548CR**  
Silla AUSTIN crema



**CG1548GP**  
Silla AUSTIN perla



**CG1548GM**  
Silla AUSTIN marengo

# Niza

Silla con asiento y respaldo tapizado. Patas de metal negras.

PUNTOS	50 x 4 UNIDADES = 200
SILLAS POR CAJA	4
PESO POR CAJA	22,3 kg



**CG1502CR**  
Silla NIZA  
crema



**CG1502GP**  
Silla NIZA  
perla



**CG1502GM**  
Silla NIZA  
marengo



**CG1502MA**  
Silla NIZA  
marrón 34



**CG1502SA**  
Silla NIZA  
salmón 52



**CG1502MO**  
Silla NIZA  
mostaza 68



**CG1502VE**  
Silla NIZA  
verde 77



**CG1502AL**  
Silla NIZA  
azul 83



**CG1502GR**  
Silla NIZA  
gris 10





# Zagreb

Silla con asiento y respaldo tapizados. Patas metálicas cromadas.

PUNTOS	50 x 4 UNIDADES = <b>200</b>
SILLAS POR CAJA	4
PESO POR CAJA	22,3 kg



**CG1500CR**  
Silla ZAGREB crema



**CG1500GP**  
Silla ZAGREB perla



**CG1500GM**  
Silla ZAGREB marengo





# Sicilia

Silla con asiento y respaldo tapizados.  
Patas metálicas negras.



PUNTOS	76 x 2 UNIDADES = <b>152</b>
SILLAS POR CAJA	2
PESO POR CAJA	15,4 kg



**CG1506CR**  
Silla SICILIA crema



**CG1506GP**  
Silla SICILIA perla



**CG1506GM**  
Silla SICILIA marengo

# Nápoles

Silla con asiento y respaldo tapizados.  
Patas metálicas cromadas.



PUNTOS	76 x 2 UNIDADES = <b>152</b>
SILLAS POR CAJA	2
PESO POR CAJA	15,4 kg



**CG1504CR**  
Silla NÁPOLES crema



**CG1504GP**  
Silla NÁPOLES perla



**CG1504GM**  
Silla NÁPOLES marengo



**CG1526CR**  
Silla CHICAGO crema



**CG1526GP**  
Silla CHICAGO perla



**CG1526GM**  
Silla CHICAGO marengo



**CG1524CR**  
Silla DETROIT crema



**CG1524GP**  
Silla DETROIT perla



**CG1524GM**  
Silla DETROIT marengo

# Detroit

Silla con asiento y respaldo tapizados.  
Patas metálicas cromadas.

PUNTOS	76 x 2 UNIDADES = <b>152</b>
SILLAS POR CAJA	2
PESO POR CAJA	15 kg



PUNTOS	76 x 2 UNIDADES = <b>152</b>
SILLAS POR CAJA	2
PESO POR CAJA	15 kg

# Chicago

Silla con asiento y respaldo tapizados.  
Patas metálicas negras.



# Cairo

Silla con asiento y respaldo tapizados. Patas de madera color negro.

PUNTOS	46 x 4 UNIDADES = <b>184</b>
SILLAS POR CAJA	4
PESO POR CAJA	25 kg



**CG1402MA**  
Silla CAIRO marrón



**CG1402GR**  
Silla CAIRO gris



# Viena

Silla con asiento y respaldo tapizados. Patas de madera.

PUNTOS	52 x 4 UNIDADES = <b>208</b>
SILLAS POR CAJA	4
PESO POR CAJA	25 kg



**CG1404MA**  
Silla VIENA marrón



**CG1404GR**  
Silla VIENA gris





# Bombay

Silla con asiento y respaldo tapizados tipo patchwork.  
Patas metálicas negras.



PUNTOS	44 x 4 UNIDADES = <b>176</b>
SILLAS POR CAJA	4
PESO POR CAJA	18,5 kg

**CG1406**  
Silla BOMBAY

# Oporto

Silla con asiento y respaldo tapizados en 4 acabados con patas metálicas negras.

PUNTOS	40 x 4 UNIDADES = <b>160</b>
SILLAS POR CAJA	4
PESO POR CAJA	18,5 kg

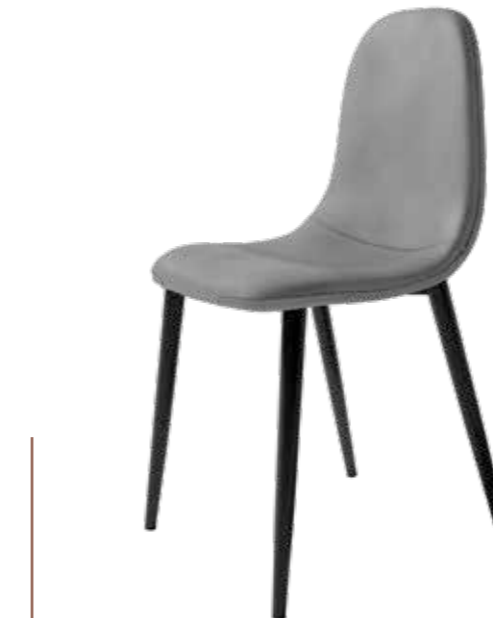

**CG1114GS**  
Silla OPORTO gris 99

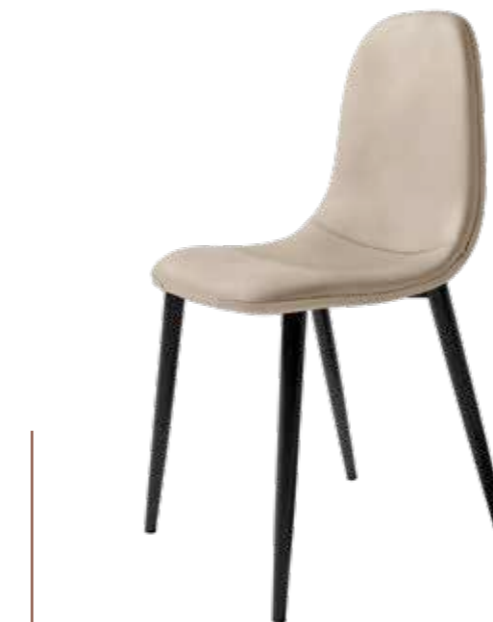

**CG1114BE**  
Silla OPORTO beige



**CG1114PL**  
Silla OPORTO plomo



**CG1114MU**  
Silla OPORTO musgo

# Dubai

Silla con respaldo de tablero contrachapado curvado en 5 acabados, asiento tapizado gris y patas metálicas negras.

PUNTOS	40 x 4 UNIDADES = <b>160</b>
SILLAS POR CAJA	4
PESO POR CAJA	16,5 kg



**CG1400C**  
Silla DUBAI cambrian

# Sofía

Silla con respaldo y asiento de tablero contrachapado curvado en 5 acabados y patas metálicas negras.

PUNTOS	32 x 4 UNIDADES = <b>128</b>
SILLAS POR CAJA	4
PESO POR CAJA	17 kg



**CG1124C**  
Silla SOFÍA cambrian



**CG1400A**  
Silla DUBAI artic



**CG1400M**  
Silla DUBAI mango



**CG1400R**  
Silla DUBAI roble



**CG1400B**  
Silla DUBAI soul blanco



**CG1124A**  
Silla SOFÍA artic



**CG1124M**  
Silla SOFÍA mango



**CG1124R**  
Silla SOFÍA roble



**CG1124B**  
Silla SOFÍA soul blanco

# Berlín



Silla con respaldo de polipropileno y asiento tapizado en polipiel. Patas de madera maciza.

PUNTOS	34 x 4 UNIDADES = <b>136</b>
SILLAS POR CAJA	4
PESO POR CAJA	20,2 kg



**CG1102DG**  
Silla BERLÍN grafito



**CG1102DB**  
Silla BERLÍN blanco

# Amsterdam

PUNTOS	44 x 4 UNIDADES = <b>176</b>
SILLAS POR CAJA	4
PESO POR CAJA	19,3 kg

Silla con asiento y respaldo tapizados. Patas de madera maciza.



**CG1534DG**  
Silla AMSTERDAM gris



**CG1534DA**  
Silla AMSTERDAM azul



# Vegas

Silla con estructura de resina transparente o fumé. Asiento tapizado de polipiel blanca. Patas de madera maciza.

PUNTOS	38 x 4 UNIDADES = <b>152</b>
SILLAS POR CAJA	4
PESO POR CAJA	21 kg



**CG1580TR**  
Silla VEGAS transparente



**CG1580FU**  
Silla VEGAS fumé

# Múnich

Silla de polipropileno con patas de madera maciza.

PUNTOS	26 x 4 UNIDADES = <b>104</b>
SILLAS POR CAJA	4
PESO POR CAJA	16 kg

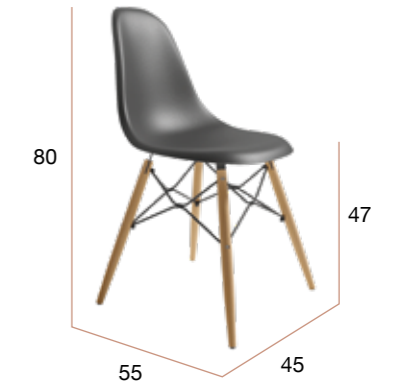

**CG1104DG**  
Silla MÚNICH grafito



**CG1104DB**  
Silla MÚNICH blanco



# Miami

Silla con asiento de polipropileno en 5 colores diferentes. Patas de madera maciza.



PUNTOS 36 x 4 UNIDADES = **144**

SILLAS POR CAJA 4

PESO POR CAJA 24 kg



**CG1546AM**  
Silla MIAMI amarillo



**CG1546BL**  
Silla MIAMI blanco



**CG1546CI**  
Silla MIAMI cielo



**CG1546GR**  
Silla MIAMI grafito



**CG1546RO**  
Silla MIAMI rosa







# London

Silla de polipropileno con patas metálicas lacadas del color del respaldo.

PUNTOS	34 x 4 UNIDADES = <b>136</b>
SILLAS POR CAJA	4
PESO POR CAJA	19,4 kg



**CG1084AN**  
Silla LONDON azulón



**CG1084GR**  
Silla LONDON grafito



**CG1084RO**  
Silla LONDON rosa



**CG1084MU**  
Silla LONDON musgo



**CG1084BL**  
Silla LONDON blanco

# Dublín

Silla de polipropileno con patas de madera maciza.

PUNTOS	36 x 4 UNIDADES = <b>144</b>
SILLAS POR CAJA	4
PESO POR CAJA	18,1 kg

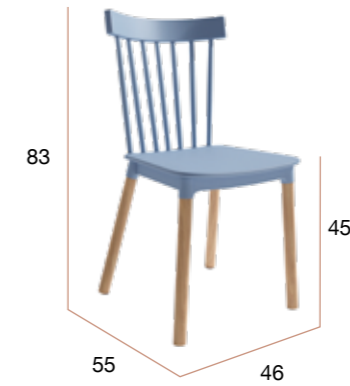

**CG1050BL**  
Silla DUBLÍN blanco



**CG1050AN**  
Silla DUBLÍN azulón



**CG1050MU**  
Silla DUBLÍN musgo



**CG1050RO**  
Silla DUBLÍN rosa



**CG1050GR**  
Silla DUBLÍN grafito



# Orlando

Silla con asiento y respaldo de polipropileno de varios colores.  
Estructura metálica color a juego con el asiento-respaldo.

PUNTOS	42 x 4 UNIDADES = <b>168</b>
SILLAS POR CAJA	4
PESO POR CAJA	22,5 kg

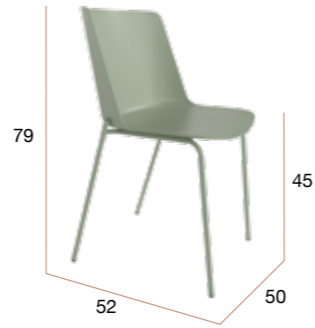

**CG1586AR**  
Silla ORLANDO  
arena



**CG1586GR**  
Silla ORLANDO  
grafito



**CG1586BL**  
Silla ORLANDO  
blanco



**CG1586VT**  
Silla ORLANDO  
verde tiza



# Berna

Silla de polipropileno con patas metálicas lacadas en el color del respaldo.

PUNTOS	32 x 4 UNIDADES = <b>128</b>
SILLAS POR CAJA	4
PESO POR CAJA	19,3 kg

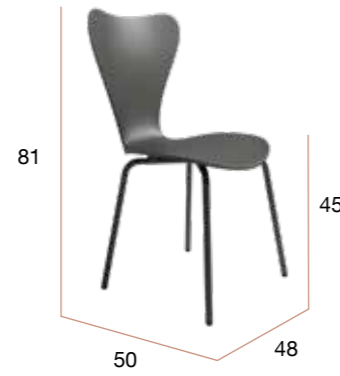

**CG1310AR**  
Silla BERNA arena



**CG1310GR**  
Silla BERNA grafito



**CG1310BL**  
Silla BERNA blanca

# Pisa

Silla de polipropileno apilable apta para uso en exteriores.

PUNTOS	38 x 4 UNIDADES = <b>152</b>
SILLAS POR CAJA	4
PESO POR CAJA	19,2 kg

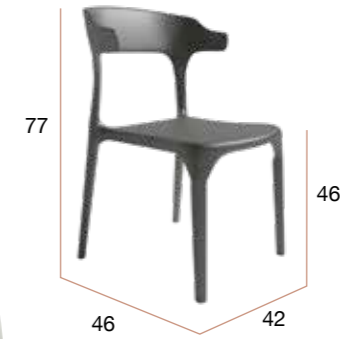

**CG1078AR**  
Silla PISA arena



**CG1078GR**  
Silla PISA grafito



**CG1078BL**  
Silla PISA blanca





# Roma

Silla de polipropileno apilable apta para uso en exteriores.



PUNTOS	44 x 4 UNIDADES = <b>176</b>
SILLAS POR CAJA	4
PESO POR CAJA	18,5 kg



**CG1052AR**  
Silla ROMA arena



**CG1052GR**  
Silla ROMA grafito



**CG1052BL**  
Silla ROMA blanca



**CG1076AR**  
Silla MILÁN arena



**CG1076GR**  
Silla MILÁN grafito



**CG1076BL**  
Silla MILÁN blanca

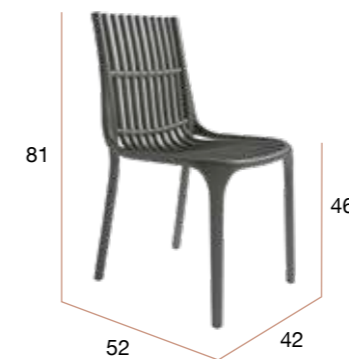

# Milán

Silla de polipropileno apilable apta para uso exteriores.

PUNTOS	44 x 4 UNIDADES = <b>176</b>
SILLAS POR CAJA	4
PESO POR CAJA	22,7 kg



# Lagos

Silla apilable de polipropileno en varios colores. Apta para uso en exteriores.

PUNTOS	40 x 4 UNIDADES = <b>160</b>
SILLAS POR CAJA	4
PESO POR CAJA	19,2 kg

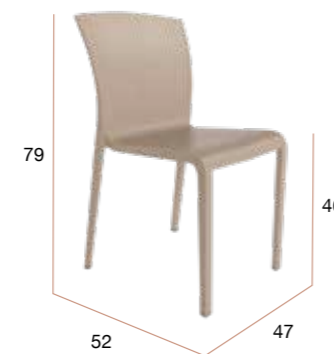

**CG1576VI**  
Silla LAGOS  
visión



**CG1576GR**  
Silla LAGOS  
grafito



**CG1576BL**  
Silla LAGOS  
blanco



**CG1080AR**  
Silla PRAGA arena



**CG1080GR**  
Silla PRAGA grafito



**CG1080BL**  
Silla PRAGA blanca



Silla de polipropileno apilable apta para uso en exteriores.

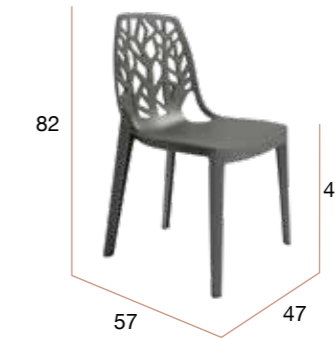

PUNTOS	50 x 4 UNIDADES = <b>200</b>
SILLAS POR CAJA	4
PESO POR CAJA	20,3 kg



# Praga

# Bogotá

Silla apilable de polipropileno en tres acabados diferentes. Apta para uso en exteriores.

PUNTOS	50 x 4 UNIDADES = <b>200</b>
SILLAS POR CAJA	4
PESO POR CAJA	19 kg

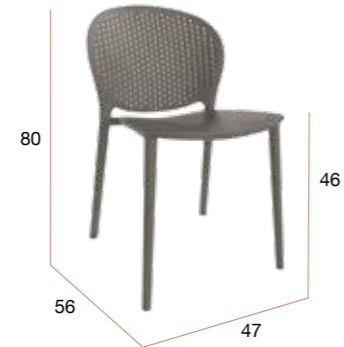

**CG1644AR**  
Silla BOGOTÁ  
arena



**CG1644GR**  
Silla BOGOTÁ  
grafito



**CG1644BL**  
Silla BOGOTÁ  
blanca



# Habana

Silla apilable de polipropileno en varios colores. Apta para uso en exteriores.

PUNTOS 56 x 4 UNIDADES = **224**

SILLAS POR CAJA 4

PESO POR CAJA 23,3 kg

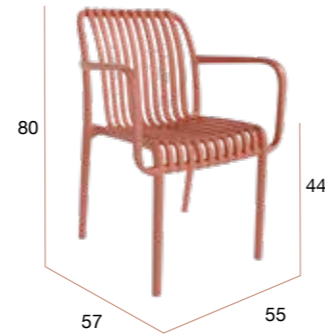

**CG1578AR**  
Silla HABANA  
arena



**CG1578GR**  
Silla HABANA  
grafito



**CG1578BL**  
Silla HABANA  
blanco



**CG1578VP**  
Silla HABANA  
verde pálido



**CG1578TJ**  
Silla HABANA  
teja



# Atenas

Silla apilable de polipropileno en tres acabados diferentes. Apta para uso en exteriores.

PUNTOS	46 x 4 UNIDADES = <b>184</b>
SILLAS POR CAJA	4
PESO POR CAJA	21 kg



**CG1642AR**  
Silla ATENAS  
arena

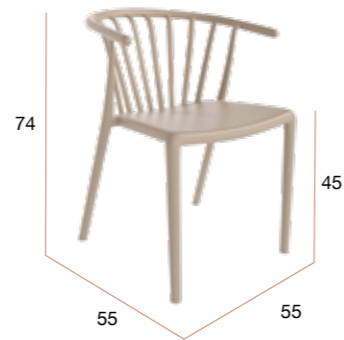

**CG1642GR**  
Silla ATENAS  
grafito



**CG1642BL**  
Silla ATENAS  
blanca







# Valeta

Silla de polipropileno en varios colores. Apilable hasta 4 unidades. Apta para uso en exteriores.

PUNTOS	50 x 4 UNIDADES = 200
SILLAS POR CAJA	4
PESO POR CAJA	23 kg

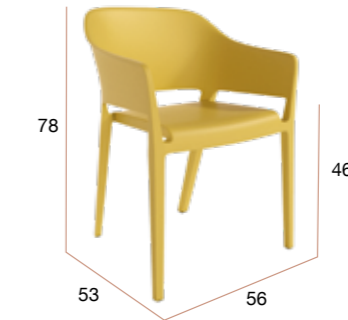

**CG1584AR**  
Silla VALETA  
arena



**CG1584GR**  
Silla VALETA  
grafito



**CG1584BL**  
Silla VALETA  
blanco



**CG1584MO**  
Silla VALETA  
mostaza





**CG1582FU**  
Silla CUZCO  
fumé

# Cuzco

Silla plegable con estructura de metal cromado.  
Asiento y respaldo de resina fumé.

PUNTOS	<b>36</b>
SILLAS POR CAJA	1
PESO POR CAJA	6.3 kg



plegada

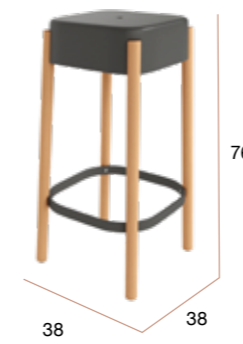

PUNTOS	60 x 2 UNIDADES = <b>120</b>
TABURETES POR CAJA	2
PESO POR CAJA	14 kg



**CG1646DG**  
Taburete VISBY  
grafito



**CG1646DB**  
Taburete VISBY  
blanco

# Visby

Taburete con patas de madera maciza y asiento de polipropileno en 2 acabados



# Bremen

Silla de oficina con ruedas. Estructura de polipropileno con asiento tapizado en polipiel.  
Patas cromadas.

PUNTOS	44
SILLAS POR CAJA	1
PESO POR CAJA	6,5 kg



**CG1522GR**  
Silla BREMEN grafito



**CG1522BL**  
Silla BREMEN blanco



**CG1522MO**  
Silla BREMEN mostaza



**CG1522TU**  
Silla BREMEN turquesa





# Bucarest

Silla de oficina con ruedas y reposa-brazos abatibles.  
Estructura negra, asiento y respaldo de tela negra.  
Patas cromadas.



**CG1518NN**  
Silla BUCAREST negro-negro

PUNTOS	<b>72</b>
SILLAS POR CAJA	1
PESO POR CAJA	10,5 kg

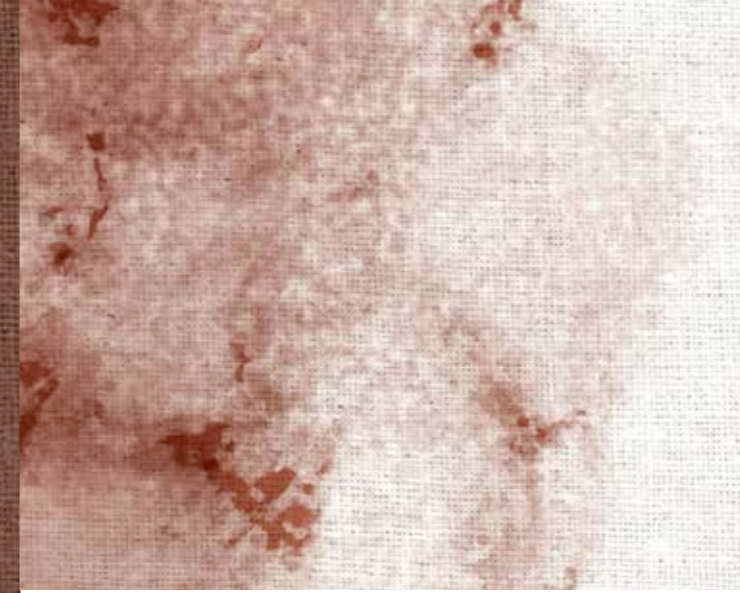

# Kiev

Silla de oficina con ruedas y reposa-brazos abatibles.  
Estructura blanca, asiento y respaldo de tela negra.  
Patas cromadas.



PUNTOS	<b>78</b>
SILLAS POR CAJA	1
PESO POR CAJA	10,5 kg



**CG1516BN**  
Silla KIEV blanca-negra



# Samara

Silla de oficina con ruedas.  
Estructura negra y respaldo de tela en tres colores.  
Patas negras.

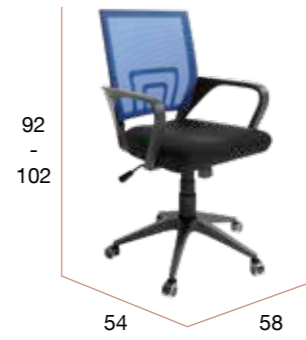

PUNTOS	54
SILLAS POR CAJA	1
PESO POR CAJA	9,6 kg

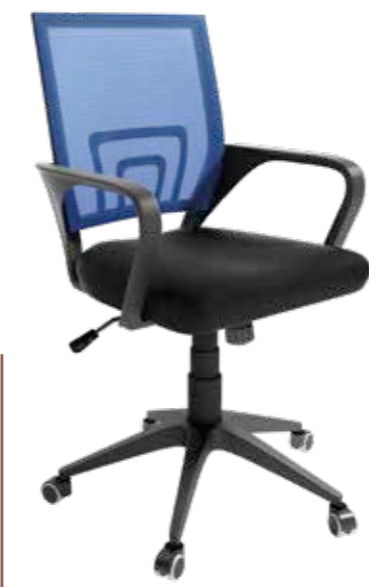

**CG1514A**  
Silla SAMARA azul



**CG1514R**  
Silla SAMARA rosa



**CG1514G**  
Silla SAMARA grafito



# Sochi

Silla de oficina con ruedas.  
Estructura negra y respaldo de tela en tres colores.  
Patas cromadas.

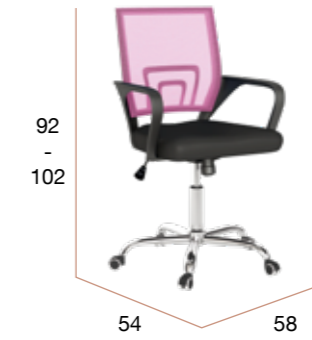

PUNTOS	54
SILLAS POR CAJA	1
PESO POR CAJA	9,6 kg



**CG1512A**  
Silla SOCHI azul



**CG1512R**  
Silla SOCHI rosa



**CG1512G**  
Silla SOCHI grafito



bogal

mesas

Ø 100



**CNG038NC**  
Mesa CANTÁBRICO Ø100 cambrian



**CNG038NA**  
Mesa CANTÁBRICO Ø100 artic



**CNG038NM**  
Mesa CANTÁBRICO Ø100 mango



**CNG038NR**  
Mesa CANTÁBRICO Ø100 roble



**CNG038NS**  
Mesa CANTÁBRICO Ø100 soul blanco

Ø 120



**CNG024NC**  
Mesa CANTÁBRICO Ø120 cambrian



**CNG024NA**  
Mesa CANTÁBRICO Ø120 artic



**CNG024NM**  
Mesa CANTÁBRICO Ø120 mango



**CNG024NR**  
Mesa CANTÁBRICO Ø120 roble



**CNG024NS**  
Mesa CANTÁBRICO Ø120 soul blanco

# Cantábrico

redonda maderas

Mesa de comedor extensible. Patas metálicas negras y sobres de Ø 100 y 120 biselados de 25 mm en 5 acabados diseño madera.

Ø 100



PUNTOS	<b>336</b>
BULTOS	2
PESO TOTAL	40,2 kg

Ø 120



PUNTOS	<b>376</b>
BULTOS	2
PESO TOTAL	54,2 kg



# Cantábrico redonda piedras

Mesa de comedor extensible. Patas metálicas negras y sobre Ø100 y 120 biselado de 25 mm en 3 acabados diseño piedra.

Ø 100



**CNG039NP**  
Mesa CANTÁBRICO Ø100  
porland



**CNG039NR**  
Mesa CANTÁBRICO Ø100  
carrara



**CNG039NQ**  
Mesa CANTÁBRICO Ø100  
marquina

Ø 120



**CNG025NP**  
Mesa CANTÁBRICO Ø120  
porland



**CNG025NR**  
Mesa CANTÁBRICO Ø120  
carrara



**CNG025NQ**  
Mesa CANTÁBRICO Ø120  
marquina

Ø 100



PUNTOS	356
BULTOS	2
PESO TOTAL	40,2 kg

Ø 120



PUNTOS	396
BULTOS	2
PESO TOTAL	54,2 kg





# Timor rectangular maderas

Mesa de comedor extensible. Patas metálicas negras y sobre biselado de 19 mm en 5 acabados diseño madera.

## 140 (180) x 90

PUNTOS	<b>298</b>
BULTOS	2
PESO TOTAL	61,9 kg

## 160 (200) x 90

PUNTOS	<b>312</b>
BULTOS	2
PESO TOTAL	65,2 kg



**CNG019NC** Mesa TIMOR 140 x 90 cambrian



**CNG018NC** Mesa TIMOR 160 x 90 cambrian



**CNG019NA** Mesa TIMOR 140 x 90 artic



**CNG018NA** Mesa TIMOR 160 x 90 artic



**CNG019NM** Mesa TIMOR 140 x 90 mango



**CNG018NM** Mesa TIMOR 160 x 90 mango



**CNG019NR** Mesa TIMOR 140 x 90 roble



**CNG018NR** Mesa TIMOR 160 x 90 roble



**CNG019NS** Mesa TIMOR 140 x 90 soul blanco



**CNG018NS** Mesa TIMOR 160 x 90 soul blanco



# Timor rectangular piedras

Mesa de comedor extensible. Patas metálicas negras y sobre biselado de 19 mm en 3 acabados diseño piedra.

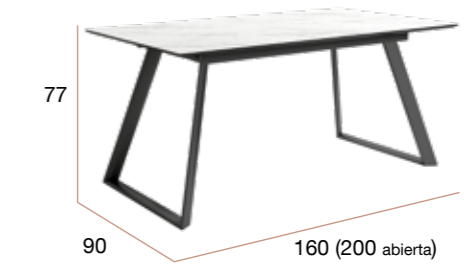
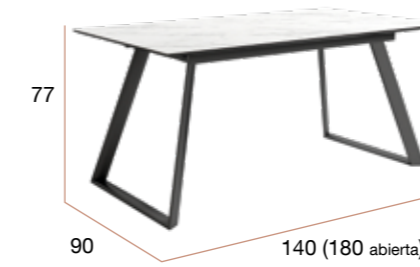

140 (180) x 90

PUNTOS	328
BULTOS	2
PESO TOTAL	61,9 kg



CNG027NP Mesa TIMOR 140 x 90 portland



CNG027NR Mesa TIMOR 140 x 90 carrara



CNG027NQ Mesa TIMOR 140 x 90 marquina

160 (200) x 90

PUNTOS	342
BULTOS	2
PESO TOTAL	65,2 kg



CNG026NP Mesa TIMOR 160 x 90 portland



CNG026NR Mesa TIMOR 160 x 90 carrara



CNG026NQ Mesa TIMOR 160 x 90 marquina

# Bering redonda maderas

Mesa de comedor fija. Patas metálicas negras y sobre biselado de Ø120 cm y 25 mm de espesor en 5 acabados diseño madera.

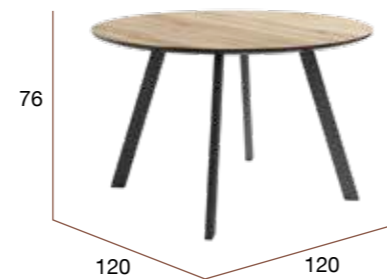

PUNTOS	180
BULTOS	2
PESO TOTAL	29,75 kg



**CNG030NC**  
Mesa BERING Ø120 cambrian



**CNG030NA**  
Mesa BERING Ø120 artic



**CNG030NR**  
Mesa BERING Ø120 roble



**CNG030NM**  
Mesa BERING Ø120 mango



**CNG030NS**  
Mesa BERING Ø120 soul blanco



# Bering redonda piedras

Mesa de comedor fija. Patas metálicas negras y sobre biselado de Ø120 cm y 25 mm de espesor en 3 acabados diseño piedra.

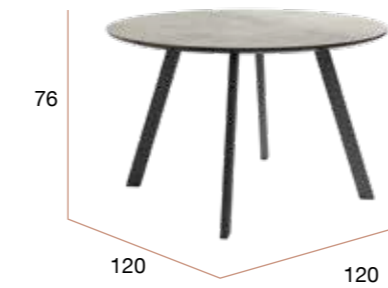

PUNTOS	200
BULTOS	2
PESO TOTAL	29,75 kg



**CNG031NP**  
Mesa BERING Ø120 porland



**CNG031NR**  
Mesa BERING Ø120 carrara



**CNG031NQ**  
Mesa BERING Ø120 marquina



# Aral rectangular maderas

Mesa de comedor fija. Patas metálicas negras y sobre biselado de 25 mm en 5 acabados diseño madera.

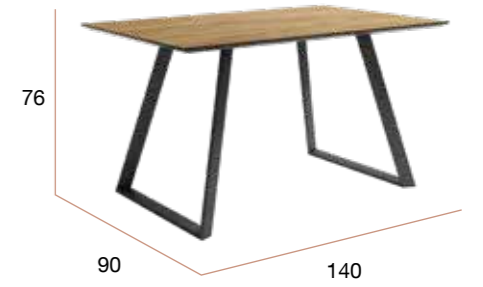

PUNTOS	190
BULTOS	2
PESO TOTAL	38,75 kg



**CNG028NC**  
Mesa ARAL cambrian



**CNG028NA**  
Mesa ARAL artic



**CNG028NM**  
Mesa ARAL mango



**CNG028NR**  
Mesa ARAL roble

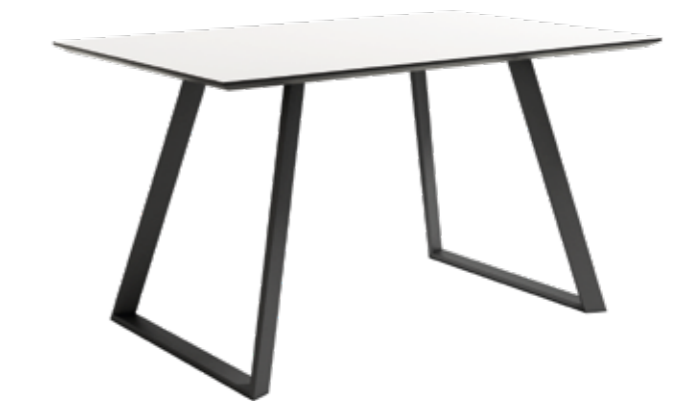

**CNG028NS**  
Mesa ARAL soul blanco



# Aral rectangular piedras

Mesa de comedor fija. Patas metálicas negras y sobre biselado de 25 mm en 3 acabados diseño piedra.



PUNTOS	210
BULTOS	2
PESO TOTAL	38,75 kg



**CNG029NP**  
Mesa ARAL portland



**CNG029NR**  
Mesa ARAL carrara



**CNG029NQ**  
Mesa ARAL marquina



# Caspio redonda maderas

Mesa de comedor fija. Patas metálicas negras y sobre biselado de Ø120 cm y 22 mm de espesor en 5 acabados diseño madera.



**CNG006NC**  
Mesa CASPIO Ø120 cambrian



PUNTOS	178
BULTOS	2
PESO TOTAL	30,5 kg



**CNG006NA**  
Mesa CASPIO Ø120 artic



**CNG006NM**  
Mesa CASPIO Ø120 mango



**CNG006NR**  
Mesa CASPIO Ø120 roble



**CNG006NS**  
Mesa CASPIO Ø120 soul blanco



# Caspio rectangular maderas

Mesa de comedor fija. Patas metálicas negras y sobre biselado de 22 mm de espesor en 5 acabados diseño madera.

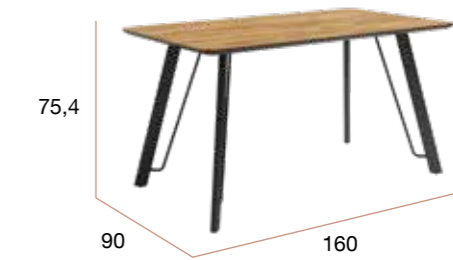
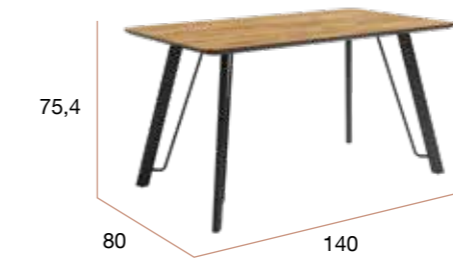

## 140 x 80

PUNTOS	<b>182</b>
BULTOS	2
PESO TOTAL	31,95 kg



**CNG004NC** Mesa CASPIO 140 x 80 cambrian



**CNG004NA** Mesa CASPIO 140 x 80 artic



**CNG004NM** Mesa CASPIO 140 x 80 mango



**CNG004NR** Mesa CASPIO 140 x 80 roble



**CNG004NS** Mesa CASPIO 140 x 80 soul blanco

## 160 x 90

PUNTOS	<b>210</b>
BULTOS	2
PESO TOTAL	40 kg



**CNG005NC** Mesa CASPIO 160 x 90 cambrian



**CNG005NA** Mesa CASPIO 160 x 90 artic



**CNG005NM** Mesa CASPIO 160 x 90 mango



**CNG005NR** Mesa CASPIO 160 x 90 roble



**CNG005NS** Mesa CASPIO 160 x 90 soul blanco





**CNG003NP**  
Mesa BALTIC Ø120 porland



**CNG003NR**  
Mesa BALTIC Ø120 carrara



**CNG003NQ**  
Mesa BALTIC Ø120 marquina

# Baltic redonda piedras

Mesa de comedor fija. Patas metálicas negras y sobre biselado de Ø120 cm y 22 mm de espesor en 3 acabados diseño piedra.



PUNTOS	<b>218</b>
BULTOS	2
PESO TOTAL	33,8 kg



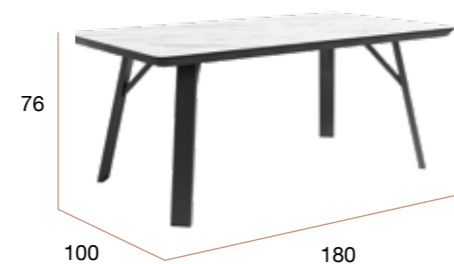
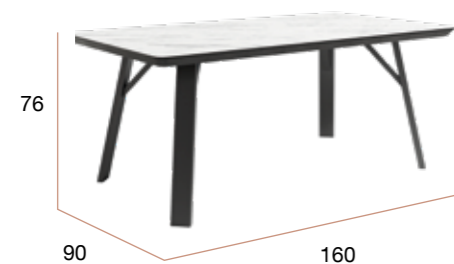

# Baltic rectangular piedras

Mesa de comedor fija. Patas metálicas negras y sobre biselado de 48 mm de espesor en 3 acabados diseño piedra.

## 160 x 90

PUNTOS	<b>240</b>
BULTOS	2
PESO TOTAL	42,2 kg



**CNG001NP**  
Mesa BALTIC 160 x 90 porland



**CNG001NR**  
Mesa BALTIC 160 x 90 carrara



**CNG001NQ**  
Mesa BALTIC 160 x 90 marquina

## 180 x 100

PUNTOS	<b>258</b>
BULTOS	2
PESO TOTAL	50 kg



**CNG002NP**  
Mesa BALTIC 180 x 100 porland



**CNG002NR**  
Mesa BALTIC 180 x 100 carrara



**CNG002NQ**  
Mesa BALTIC 180 x 100 marquina





# Adriático rectangular pedras

Mesa de comedor extensible. Patas metálicas negras y sobre biselado de 38 mm de espesor en 3 acabados diseño piedra.

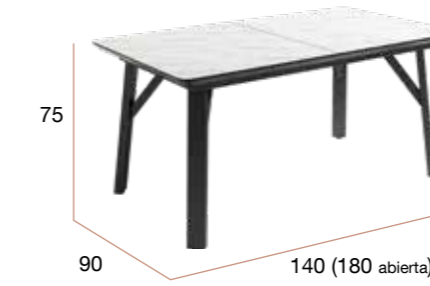

140 (180) x 90

PUNTOS	368
BULTOS	2
PESO TOTAL	63,3 kg



**CNG032NP**  
Mesa ADRIÁTICO 140 x 90 portland



**CNG032NR**  
Mesa ADRIÁTICO 140 x 90 carrara



**CNG032NQ**  
Mesa ADRIÁTICO 140 x 90 marquina

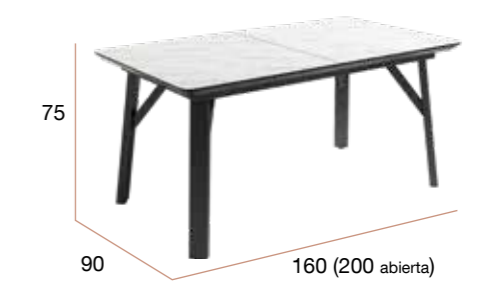

160 (200) x 90

PUNTOS	382
BULTOS	2
PESO TOTAL	66,5 kg



**CNG023NP**  
Mesa ADRIÁTICO 160 x 90 portland



**CNG023NR**  
Mesa ADRIÁTICO 160 x 90 carrara



**CNG023NQ**  
Mesa ADRIÁTICO 160 x 90 marquina

# Alborán redonda cristal

Mesa de comedor fija. Patas metálicas negras y sobre de cristal de Ø120 cm y 12 mm de espesor.

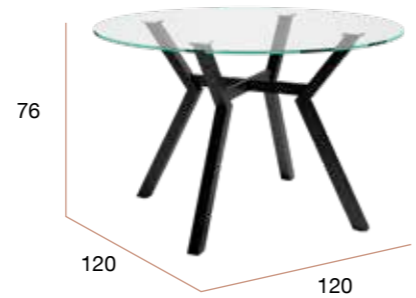

PUNTOS	210
BULTOS	2
PESO TOTAL	51 kg

**CNG007NL**  
Mesa ALBORÁN Ø120



bogal

# Alborán rectangular cristal

Mesa de comedor fija. Patas metálicas negras y sobre de cristal de 12 mm.

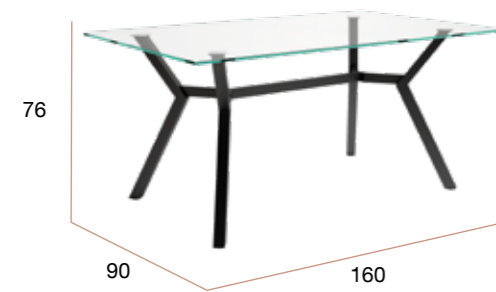

PUNTOS	250
BULTOS	2
PESO TOTAL	60 kg



**CNG009NL**  
Mesa ALBORÁN 160 x 90

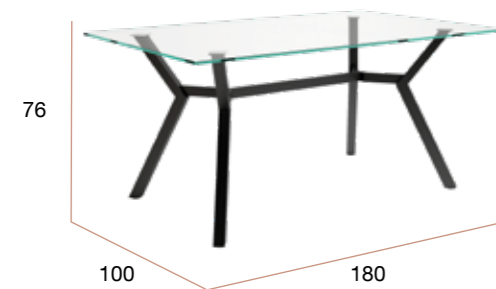

PUNTOS	260
BULTOS	2
PESO TOTAL	71,5 kg



**CNG008NL**  
Mesa ALBORÁN 180 x 100



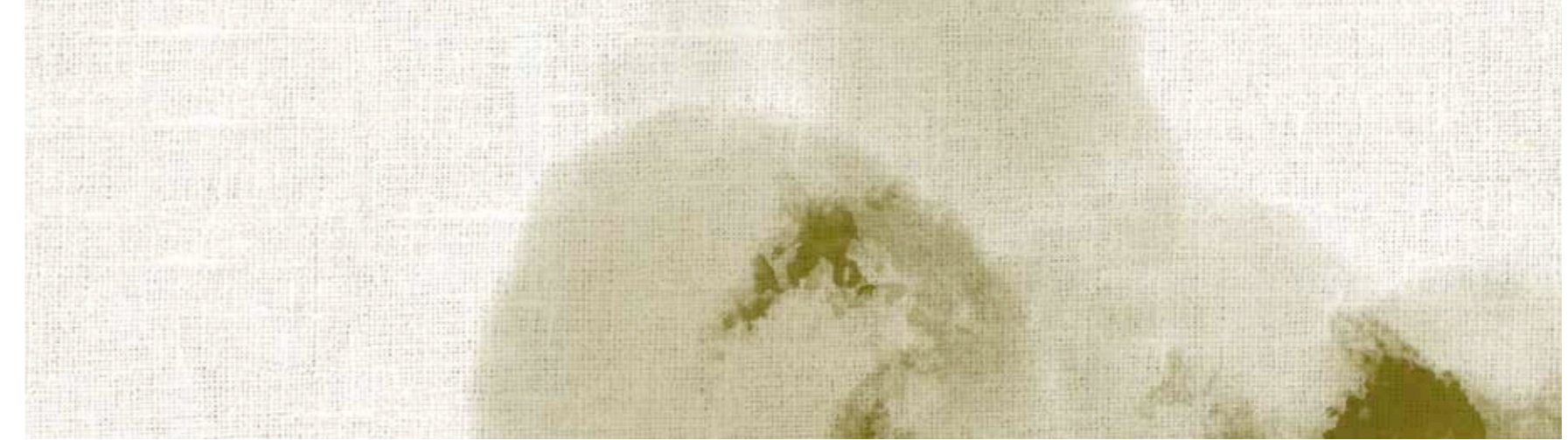

# Mar

Mesa con estructura metálica negra con sobre cerámico marquina en dos tamaños.  
Mesa con estructura metálica blanca con sobre cerámico carrara en dos tamaños.

Ø 80

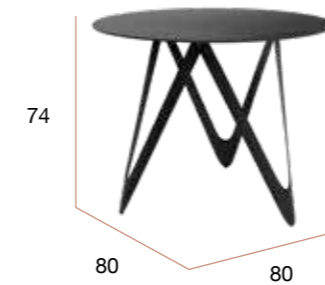

PUNTOS	156
BULTOS	2
PESO POR MESA	24 kg



**CNG034NQ**  
Mesa MAR Ø80 marquina



**CNG034BR**  
Mesa MAR Ø80 carrara

Ø 100

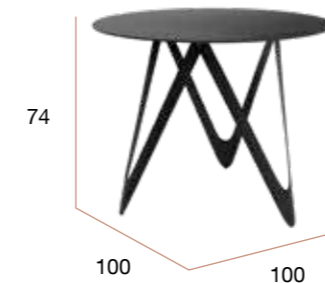

PUNTOS	170
BULTOS	2
PESO POR MESA	33 kg



**CNG035NQ**  
Mesa MAR Ø100 marquina



**CNG035BR**  
Mesa MAR Ø100 carrara



# Caribe redonda

Mesa de comedor fija redonda. Patas de madera con regulación en la base y sobre de MDF lacado de Ø90 cm.

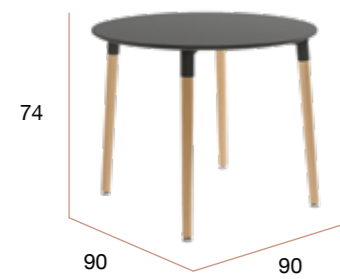

PUNTOS	<b>100</b>
BULTOS	1
PESO POR CAJA	18,8 kg



**CG1098DB**  
Mesa CARIBE Ø90 blanca



**CG1098DG**  
Mesa CARIBE Ø90 grafito





# Caribe cuadrada

Mesa de comedor fija cuadrada. Patas de madera con regulación en la base y sobre de MDF lacado de 80 x 80 cm.

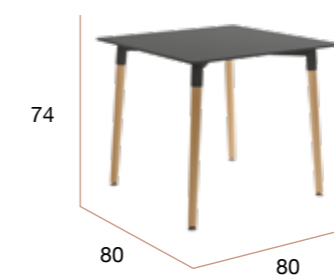

PUNTOS	<b>88</b>
BULTOS	1
PESO POR CAJA	15,7 kg



**CG1100DG**  
Mesa CARIBE 80 x 80 grafito



**CG1100DB**  
Mesa CARIBE 80 x 80 blanca





# Caribe rectangular

Mesa de comedor fija rectangular. Patas de madera con regulación en la base y sobre de MDF lacado en dos medidas.

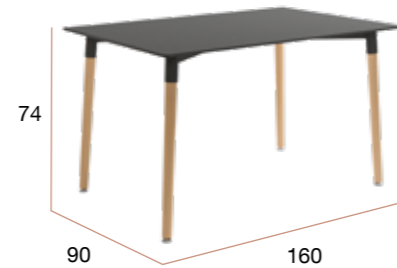
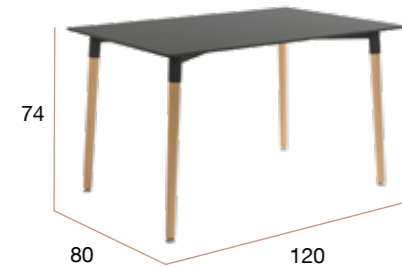

**120 x 80**

PUNTOS	<b>100</b>
BULTOS	1
PESO POR CAJA	16,2 kg



**CG1094DB**  
Mesa CARIBE 120 x 80 blanca



**CG1094DG**  
Mesa CARIBE 120 x 80 grafito

**160 x 90**

PUNTOS	<b>146</b>
BULTOS	1
PESO POR CAJA	25,5 kg



**CG1096DB**  
Mesa CARIBE 160 x 90 blanca



**CG1096DG**  
Mesa CARIBE 160 x 90 grafito



# Sulu

Mesa apta para uso exterior con patas de polipropileno reforzadas y sobre en polipropileno.

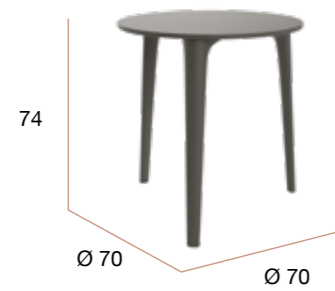

PUNTOS	84
BULTOS	2
PESO POR MESA	14,2 kg



**CNG036BL**  
Mesa SULU redonda Ø70  
Blanca



**CNG036GR**  
Mesa SULU redonda Ø70  
Grafito



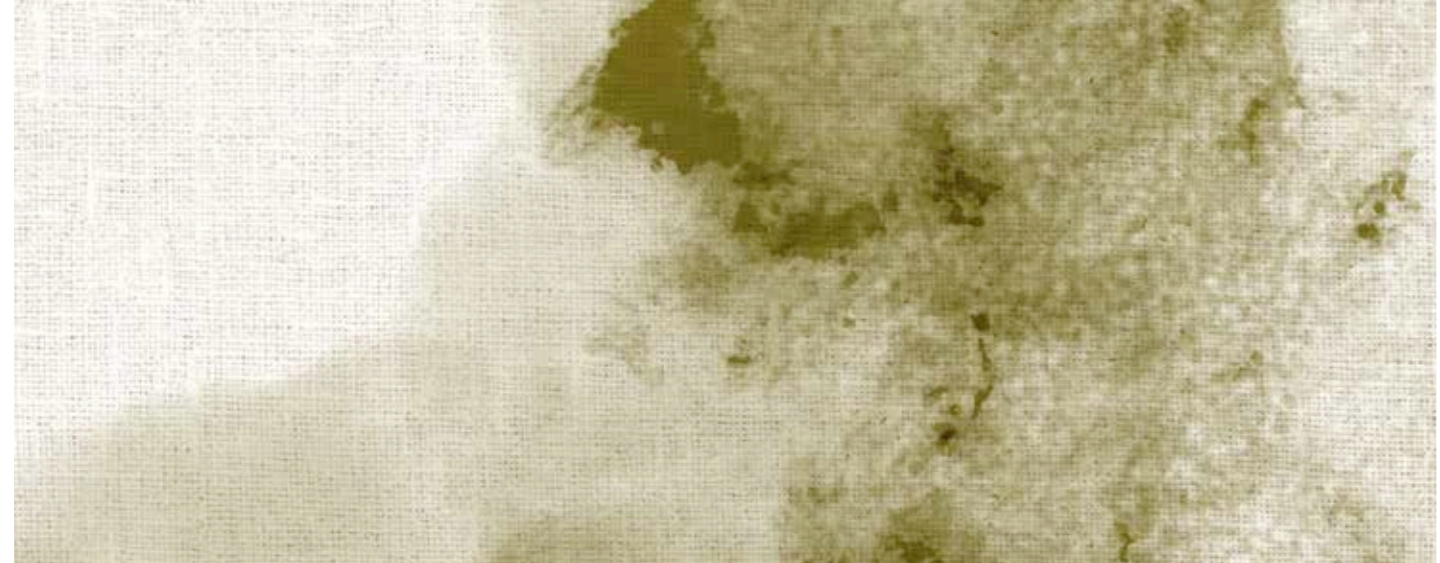

# Kara

Mesa apta para uso exterior con patas de polipropileno reforzadas y sobre de polipropileno.

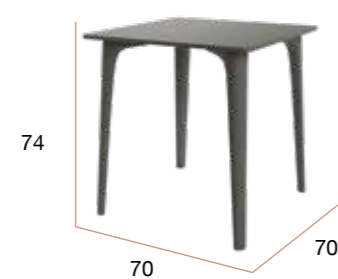

PUNTOS	102
BULTOS	2
PESO POR MESA	18,1 kg



**CNG037BL**  
Mesa KARA cuadrada 70  
Blanca



**CNG037GR**  
Mesa KARA cuadrada 70  
Grafito





# Jónico

Mesa con 3 patas de metal lacadas y sobre de polipropileno redondo.

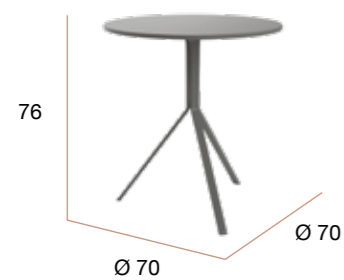

PUNTOS	80
BULTOS	1
PESO POR CAJA	12,4 kg



**CG1660BL**  
Mesa JÓNICO redonda Ø70  
Blanca



**CG1660GR**  
Mesa JÓNICO redonda Ø70  
Grafito



bogal

mesas  
de centro

# Egeo Ø80

bogal

Mesa de centro redonda. Patas metálicas negras y sobre biselado de Ø80 cm y 25 mm de espesor en 3 acabados diseño piedra.

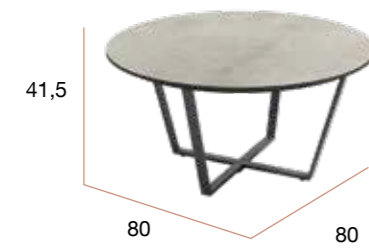

PUNTOS	90
MESAS POR CAJA	1
PESO POR CAJA	14 kg



**CG1040NP**  
Mesa EGEO Ø80 porland



**CG1040NR**  
Mesa EGEO Ø80 carrara



**CG1040NQ**  
Mesa EGEO Ø80 marquina





# Egeo Ø40

Mesa auxiliar redonda. Patas metálicas negras y sobre biselado de Ø40 cm y 25 mm de espesor en 3 acabados diseño piedra.

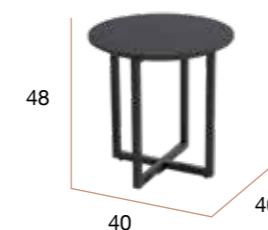

PUNTOS	72
MESAS POR CAJA	1
PESO POR CAJA	3,5 kg



**CG1044NP**  
Mesa EGEO Ø40 porland



**CG1044NR**  
Mesa EGEO Ø40 carrara



**CG1044NQ**  
Mesa EGEO Ø40 marquina

# Egeo rectangular

Mesa de centro rectangular. Patas metálicas negras y sobre biselado de 120 x 60 cm y 25 mm de espesor en 3 acabados diseño piedra.

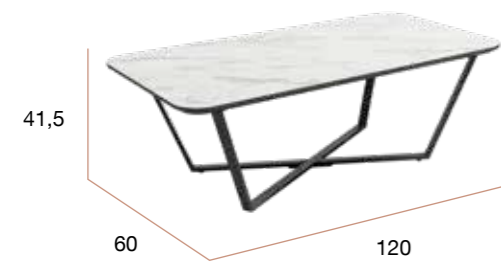

PUNTOS	116
MESAS POR CAJA	1
PESO POR CAJA	17 kg



**CG1036NR**  
Mesa EGEO 120 x 60 carrara



**CG1036NP**  
Mesa EGEO 120 x 60 porland



**CG1036NQ**  
Mesa EGEO 120 x 60 marquina





# Pacífico Ø80

Mesa de centro redonda Ø80 cm con estructura de metal negro y sobre de tablero de 15 mm de espesor.



**CNG020NC**  
Mesa PACÍFICO Ø80 cambrian

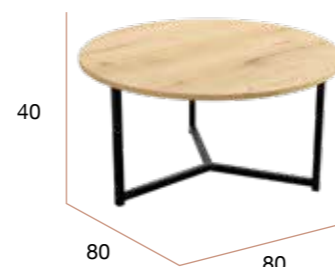

PUNTOS	58
BULTOS	2
PESO TOTAL	9,79 kg



**CNG020NA**  
Mesa PACÍFICO Ø80 artic



**CNG020NM**  
Mesa PACÍFICO Ø80 mango



**CNG020NR**  
Mesa PACÍFICO Ø80 roble



**CNG020NS**  
Mesa PACÍFICO Ø80 soul blanco



# Pacífico Ø50

Mesa auxiliar redonda Ø50 cm con estructura de metal negro y sobre de tablero de 15 mm de espesor.

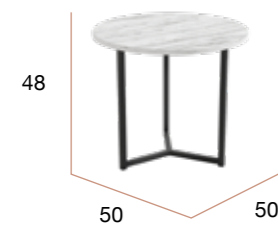

PUNTOS	42
BULTOS	2
PESO TOTAL	5,3 kg



**CNG021NC**  
Mesa PACÍFICO Ø50 cambrian



**CNG021NA**  
Mesa PACÍFICO Ø50 artic



**CNG021NM**  
Mesa PACÍFICO Ø50 mango



**CNG021NR**  
Mesa PACÍFICO Ø50 roble



**CNG021NS**  
Mesa PACÍFICO Ø50 soul blanco





# Pacífico rectangular

Mesa de centro rectangular de 100 x 50 cm con estructura de metal negro y sobre de tablero de 15 mm de espesor.

PUNTOS	60
BULTOS	2
PESO TOTAL	11,7 kg

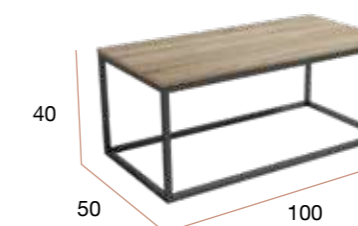

**CNG022NC**  
Mesa PACÍFICO 100 x 50 cambrian



**CNG022NA**  
Mesa PACÍFICO 100 x 50 artic



**CNG022NM**  
Mesa PACÍFICO 100 x 50 mango



**CNG022NR**  
Mesa PACÍFICO 100 x 50 roble



**CNG022NS**  
Mesa PACÍFICO 100 x 50 soul blanco

# Índico Ø60

Mesa de centro redonda Ø60 cm con estructura metálica y sobre de tablero.

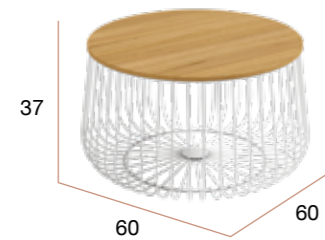

PUNTOS	98
MESAS POR CAJA	1
PESO POR CAJA	10,6 kg



**CG1106ND**  
Mesa centro ÍNDICO Ø60  
estructura negra - sobre madera



**CG1106BD**  
Mesa centro ÍNDICO Ø60  
estructura blanca - sobre madera



**CG1106NN**  
Mesa centro ÍNDICO Ø60  
estructura negra - sobre negro



**CG1106BB**  
Mesa centro ÍNDICO Ø60  
estructura blanca - sobre blanco



# Índico Ø35

Mesa auxiliar redonda Ø35 cm con estructura metálica y sobre de tablero.

PUNTOS	66
MESAS POR CAJA	1
PESO POR CAJA	5,9 kg

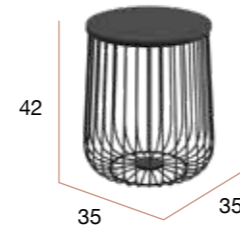

**CG1110ND**  
Mesa auxiliar ÍNDICO Ø35  
estructura negra - sobre madera



**CG1110BD**  
Mesa auxiliar ÍNDICO Ø35  
estructura blanca - sobre madera



**CG1110NN**  
Mesa auxiliar ÍNDICO Ø35  
estructura negra - sobre negro



**CG1110BB**  
Mesa auxiliar ÍNDICO Ø35  
estructura blanca - sobre blanco





# Atlántico Ø60

Mesa de centro redonda Ø60 cm con estructura metálica y sobre de tablero.

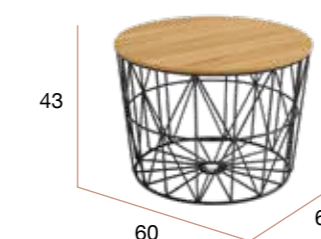

PUNTOS	<b>108</b>
MESAS POR CAJA	1
PESO POR CAJA	10,2 kg



**CG1108ND**  
Mesa centro ATLÁNTICO Ø60  
estructura negra - sobre madera



**CG1108BD**  
Mesa centro ATLÁNTICO Ø60  
estructura blanca - sobre madera



**CG1108NN**  
Mesa centro ATLÁNTICO Ø60  
estructura negra - sobre negro

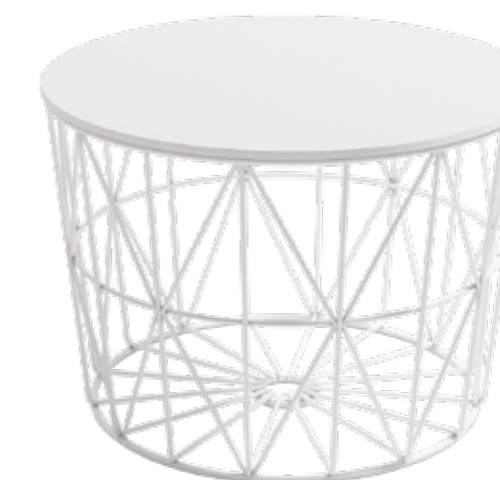

**CG1108BB**  
Mesa centro ATLÁNTICO Ø60  
estructura blanca - sobre blanco



# Atlántico Ø48

Mesa auxiliar redonda Ø48 cm con estructura metálica y sobre de tablero.

PUNTOS	78
MESAS POR CAJA	1
PESO POR CAJA	8 kg

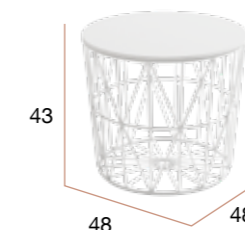

**CG1112ND**  
Mesa auxiliar ATLÁNTICO Ø48  
estructura negra - sobre madera



**CG1112BD**  
Mesa auxiliar ATLÁNTICO Ø48  
estructura blanca - sobre madera

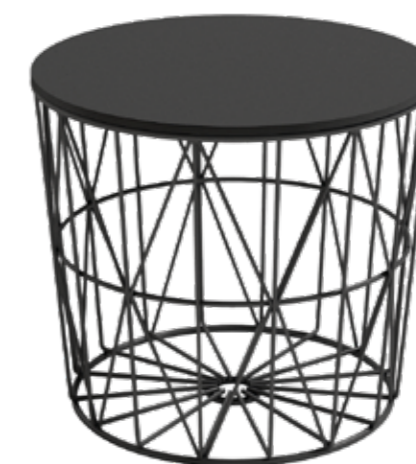

**CG1112NN**  
Mesa auxiliar ATLÁNTICO Ø48  
estructura negra - sobre negro



**CG1112BB**  
Mesa auxiliar ATLÁNTICO Ø48  
estructura blanca - sobre blanco

# Antartic

Mesa auxiliar metálica lacada en 5 colores diferentes.

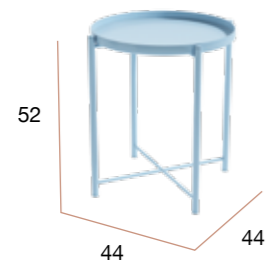

PUNTOS	20
MESAS POR CAJA	1
PESO POR CAJA	4 kg



**CG1126AZ**  
Mesa auxiliar ANTARTIC azul



**CG1126AR**  
Mesa auxiliar ANTARTIC arena



**CG1126NE**  
Mesa auxiliar ANTARTIC grafito



**CG1126BL**  
Mesa auxiliar ANTARTIC blanco



**CG1126VE**  
Mesa auxiliar ANTARTIC verde





bogal

butacas



# Ada

Butaca relax manual y relax + power lift eléctrico.  
Tapizado en dos acabados.

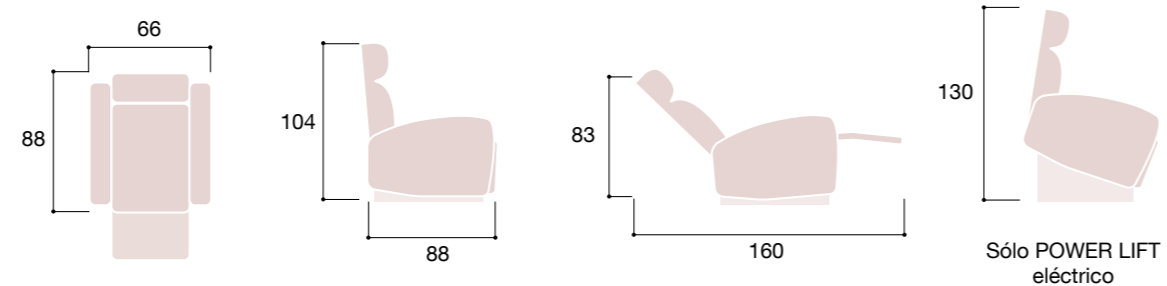

accionador manual



mando eléctrico



conector CA



## relax manual



**CG1600PE**  
Relax manual  
tapizado Perla 13

**PUNTOS 160**  
1 CAJA / PESO: 30 kg



**CG1600PI**  
Relax manual  
tapizado Pizarra 17

**PUNTOS 160**  
1 CAJA / PESO: 30 kg

### ESTRUCTURA

Estructura de hierro pintado color negro y tablero contrachapado.

### BASE SE SUSTENTACIÓN

Entrelazado de muelles metálicos de 1 mm en zigzag con cincha de alta resistencia.

### COJINES DE ASIENTOS

Núcleo de muelles ensacados individualmente cubiertos de espuma de poliuretano (densidad 30 kg/m3) y fibra hueca siliconada.

### COJINES BRAZOS Y RESPALDO

Relleno de fibra hueca virgen siliconada. La mejor calidad en cuanto a resistencia, recuperación y absorción.

## relax + power lift eléctrico



**CG1602PE**  
Relax + power lift eléctrico  
tapizado Perla 13

**PUNTOS 216**  
1 CAJA / PESO: 40 kg



**CG1602PI**  
Relax + power lift eléctrico  
tapizado Pizarra 17

**PUNTOS 216**  
1 CAJA / PESO: 40 kg



# Elsa

Butaca relax manual y relax + power lift eléctrico.  
Tapizado en dos acabados.

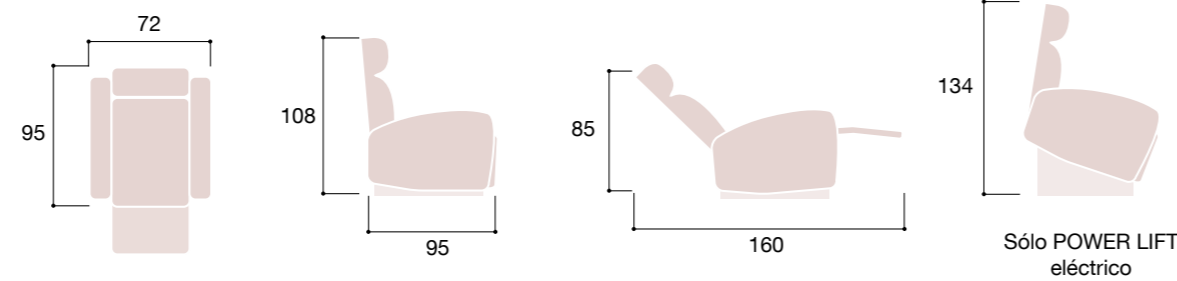

accionador manual



mando eléctrico



conector CA



## relax manual



**CG1604TI**  
Relax manual  
tapizado Tierra 02

**PUNTOS 166**  
1 CAJA / PESO: 33 kg



**CG1604GR**  
Relax manual  
tapizado Gris 14

**PUNTOS 166**  
1 CAJA / PESO: 33 kg

## relax + power lift eléctrico



**CG1606TI**  
Relax + power lift eléctrico  
tapizado Tierra 02

**PUNTOS 222**  
1 CAJA / PESO: 43 kg



**CG1606GR**  
Relax + power lift eléctrico  
tapizado Gris 14

**PUNTOS 222**  
1 CAJA / PESO: 43 kg

### ESTRUCTURA

Estructura de hierro pintado color negro y tablero contrachapado.

### BASE SE SUSTENTACIÓN

Entrelazado de muelles metálicos de 1 mm en zigzag con cincha de alta resistencia.

### COJINES DE ASIENTOS

Núcleo de muelles ensacados individualmente cubiertos de espuma de poliuretano (densidad 30 kg/m3) y fibra hueca siliconada.

### COJINES BRAZOS Y RESPALDO

Relleno de fibra hueca virgen siliconada. La mejor calidad en cuanto a resistencia, recuperación y absorción.

# Fiona

Butaca relax manual y relax + power lift eléctrico de 1 ó 2 motores.  
Tapizado en dos acabados.

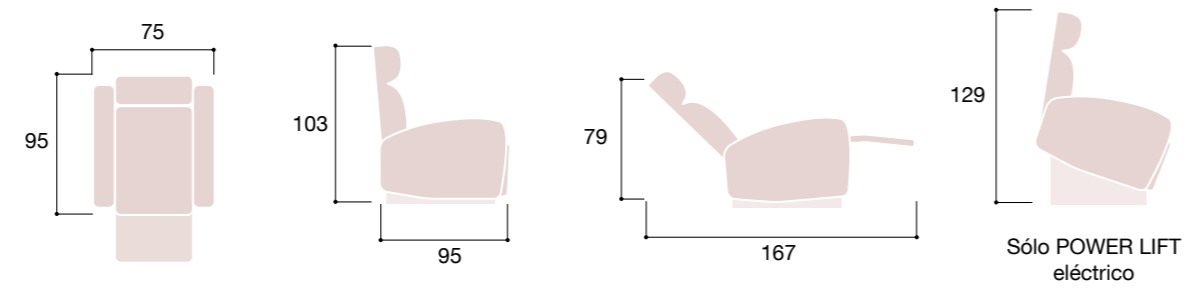

## relax manual



**CG1608TI**  
Sillón relax manual  
tapizado Tierra 02

**PUNTOS 170**  
1 CAJA / PESO: 32 kg



**CG1608GR**  
Sillón relax manual  
tapizado Gris 14

**PUNTOS 170**  
1 CAJA / PESO: 32 kg



accionador manual

## relax + power lift eléctrico



**CG1610TI**  
Sillón relax + power lift eléctrico  
tapizado Tierra 02

**PUNTOS 228**  
1 CAJA / PESO: 42kg



**CG1610GR**  
Sillón relax + power lift eléctrico  
tapizado Gris 14

**PUNTOS 228**  
1 CAJA / PESO: 42kg



mando eléctrico 1 motor

## relax + power lift (2 MOTORES)



**CG1612TI**  
Sillón relax + power lift 2 motores  
tapizado Tierra 02

**PUNTOS 284**  
1 CAJA / PESO: 48 kg



**CG1612GR**  
Sillón relax + power lift 2 motores  
tapizado Gris 14

**PUNTOS 284**  
1 CAJA / PESO: 48 kg



mando eléctrico 2 motores



# Diana

Butaca relax manual y relax + power lift eléctrico.  
Tapizado en dos acabados.

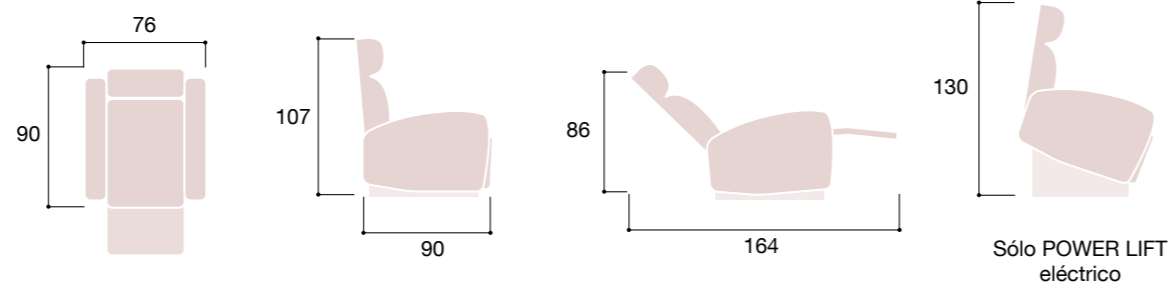

accionador manual



mando eléctrico



conector CA



## relax manual



**CG1614PE**  
Relax manual  
tapizado Perla 13

**PUNTOS 184**  
1 CAJA / PESO: 32 kg



**CG1614PI**  
Relax manual  
tapizado Pizarra 17

**PUNTOS 184**  
1 CAJA / PESO: 32 kg

## relax + power lift eléctrico



**CG1616PE**  
Relax + power lift eléctrico  
tapizado Perla 13

**PUNTOS 240**  
1 CAJA / PESO: 42 kg



**CG1616PI**  
Relax + power lift eléctrico  
tapizado Pizarra 17

**PUNTOS 240**  
1 CAJA / PESO: 42 kg

### ESTRUCTURA

Estructura de hierro pintado color negro y tablero contrachapado.

### BASE SE SUSTENTACIÓN

Entrelazado de muelles metálicos de 1 mm en zigzag con cincha de alta resistencia.

### COJINES DE ASIENTOS

Núcleo de muelles ensacados individualmente cubiertos de espuma de poliuretano (densidad 30 kg/m3) y fibra hueca siliconada.

### COJINES BRAZOS Y RESPALDO

Relleno de fibra hueca virgen siliconada. La mejor calidad en cuanto a resistencia, recuperación y absorción.



accionador manual



relax manual



**CG1618TI**  
Relax manual  
tapizado Tierra 02

**PUNTOS 184**  
1 CAJA / PESO: 34 kg



**CG1618PE**  
Relax manual  
tapizado Perla 13

**PUNTOS 184**  
1 CAJA / PESO: 34 kg



**CG1618GR**  
Relax manual  
tapizado Gris 14

**PUNTOS 184**  
1 CAJA / PESO: 34 kg



**CG1618PI**  
Relax manual  
tapizado Pizarra 17

**PUNTOS 184**  
1 CAJA / PESO: 34 kg

**ESTRUCTURA**

Estructura de hierro pintado color negro y tablero contrachapado.

**BASE SE SUSTENTACIÓN**

Entrelazado de muelles metálicos de 1 mm en zigzag con cincha de alta resistencia.

**COJINES DE ASIENTOS**

Núcleo de muelles ensacados individualmente cubiertos de espuma de poliuretano (densidad 30 kg/m3) y fibra hueca siliconada.

**COJINES BRAZOS Y RESPALDO**

Relleno de fibra hueca virgen siliconada. La mejor calidad en cuanto a resistencia, recuperación y absorción.

# Celia manual

Butaca relax manual.  
Tapizado en 4 acabados.

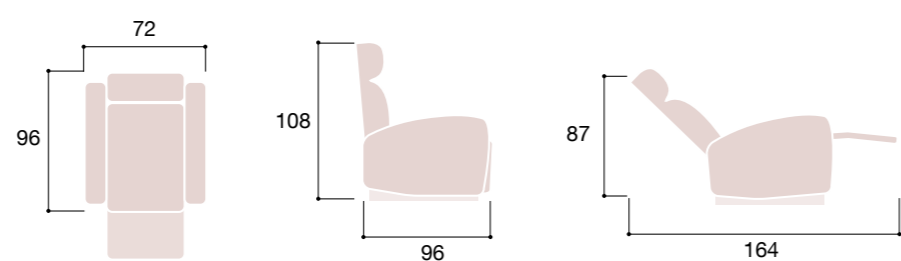

relax + power lift eléctrico



**CG1620TI**  
Relax / power lift eléctrico  
tapizado Tierra 02

**PUNTOS 240**  
1 CAJA / PESO: 44 kg



**CG1620PE**  
Relax / power lift eléctrico  
tapizado Perla 13

**PUNTOS 240**  
1 CAJA / PESO: 44 kg



**CG1620GR**  
Relax / power lift eléctrico  
tapizado Gris 14

**PUNTOS 240**  
1 CAJA / PESO: 44 kg



**CG1620PI**  
Relax / power lift eléctrico  
tapizado Pizarra 17

**PUNTOS 240**  
1 CAJA / PESO: 44 kg



relax + power lift (2 MOTORES)



**CG1622TI**  
Relax / power lift 2 motores  
tapizado Tierra 02

**PUNTOS 296**  
1 CAJA / PESO: 50 kg



**CCG1622PE**  
Relax / power lift 2 motores  
tapizado Perla 13

**PUNTOS 296**  
1 CAJA / PESO: 50 kg



**CG1622GR**  
Relax / power lift 2 motores  
tapizado Gris 14

**PUNTOS 296**  
1 CAJA / PESO: 50 kg



**CG1622PI**  
Relax / power lift 2 motores  
tapizado Pizarra 17

**PUNTOS 296**  
1 CAJA / PESO: 50 kg

**ESTRUCTURA**

Estructura de hierro pintado color negro y tablero contrachapado.

**BASE SE SUSTENTACIÓN**

Entrelazado de muelles metálicos de 1 mm en zigzag con cincha de alta resistencia.

**COJINES DE ASIENTOS**

Núcleo de muelles ensacados individualmente cubiertos de espuma de poliuretano (densidad 30 kg/m3) y fibra hueca siliconada.

**COJINES BRAZOS Y RESPALDO**

Relleno de fibra hueca virgen siliconada. La mejor calidad en cuanto a resistencia, recuperación y absorción.

# Celia eléctrico

Butaca relax + power lift eléctrico con 1 ó 2 motores.  
Tapizado en 4 acabados.

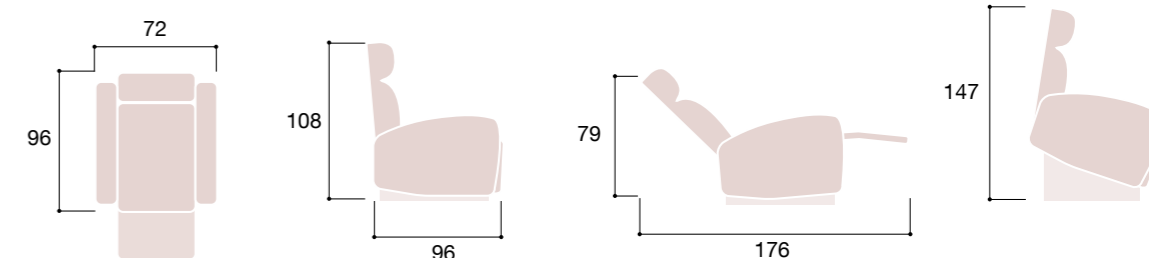

conector CA



mando eléctrico  
1 motor



mando eléctrico  
2 motores



# Cloe

Butaca relax manual y relax + power lift eléctrico.  
Tapizado en dos acabados.

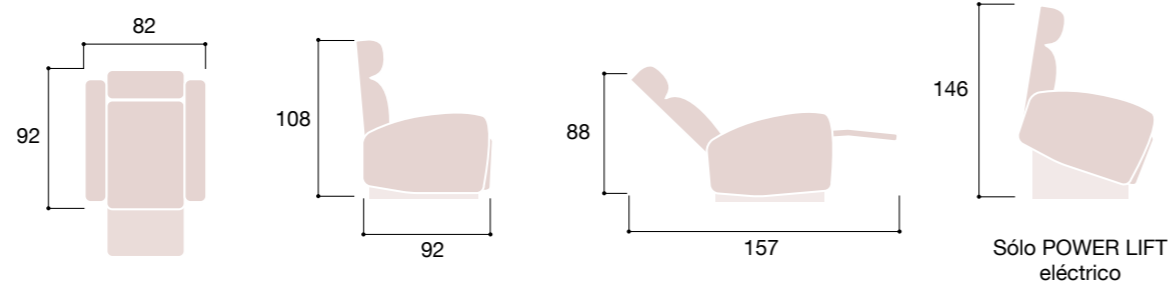

accionador manual



mando eléctrico



conector CA



## relax manual



**CG1624TI**  
Relax manual  
tapizado Tierra 02

**PUNTOS 188**  
1 CAJA / PESO: 36 kg



**CG1624GR**  
Relax manual  
tapizado Gris 14

**PUNTOS 188**  
1 CAJA / PESO: 36 kg

## relax + power lift eléctrico



**CG1626TI**  
Relax + power lift eléctrico  
tapizado Tierra 02

**PUNTOS 244**  
1 CAJA / PESO: 46 kg



**CG1626GR**  
Relax + power lift eléctrico  
tapizado Gris 14

**PUNTOS 244**  
1 CAJA / PESO: 46 kg

### ESTRUCTURA

Estructura de hierro pintado color negro y tablero contrachapado.

### BASE SE SUSTENTACIÓN

Entrelazado de muelles metálicos de 1 mm en zigzag con cincha de alta resistencia.

### COJINES DE ASIENTOS

Núcleo de muelles ensacados individualmente cubiertos de espuma de poliuretano (densidad 30 kg/m3) y fibra hueca siliconada.

### COJINES BRAZOS Y RESPALDO

Relleno de fibra hueca virgen siliconada. La mejor calidad en cuanto a resistencia, recuperación y absorción.





# Zoe gris

Sofás de 1 plaza relax manual y eléctrico, de 2 plazas fijo, relax manual y eléctrico y 3 plazas relax manual y eléctrico.



accionador manual



accionador eléctrico con cargador USB

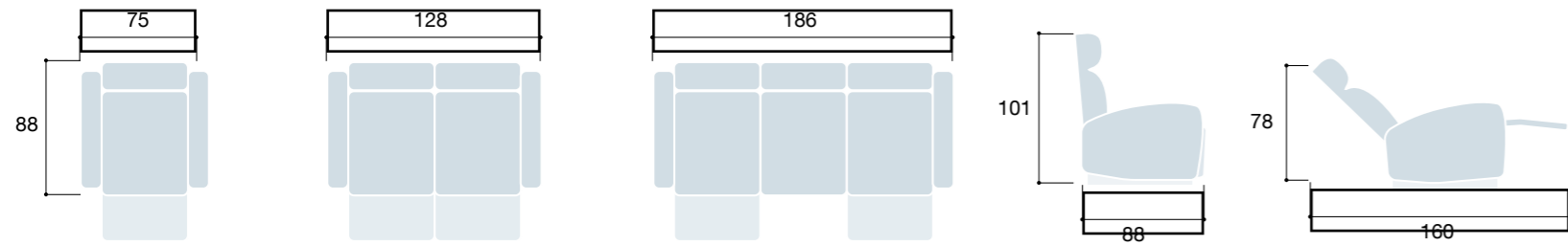

## relax manual



**CG1628GR**  
Relax manual  
tapizado Gris 14

**PUNTOS 172**  
1 CAJA / PESO: 31,5 kg



**CG1634GR**  
Relax manual  
tapizado Gris 14

**PUNTOS 282**  
1 CAJA / PESO: 55 kg



**CG1638GR**  
Relax manual (sólo extremos)  
tapizado Gris 14

**PUNTOS 374**  
1 CAJA / PESO: 69 kg

## relax eléctrico



**CG1630GR**  
Relax eléctrico  
tapizado Gris 14

**PUNTOS 220**  
1 CAJA / PESO: 32 kg



**CG1636GR**  
Relax eléctrico  
tapizado Gris 14

**PUNTOS 378**  
1 CAJA / PESO: 57,5 kg



**CG1640GR**  
Relax eléctrico (sólo extremos)  
tapizado Gris 14

**PUNTOS 472**  
1 CAJA / PESO: 72 kg

## fijo



**CG1632GR**  
Fijo  
tapizado Gris 14

**PUNTOS 236**  
1 CAJA / PESO: 35 kg

# Zoe pizarra



Sofás de 1 plaza relax manual y eléctrico, de 2 plazas fijo, relax manual y eléctrico y 3 plazas relax manual y eléctrico.

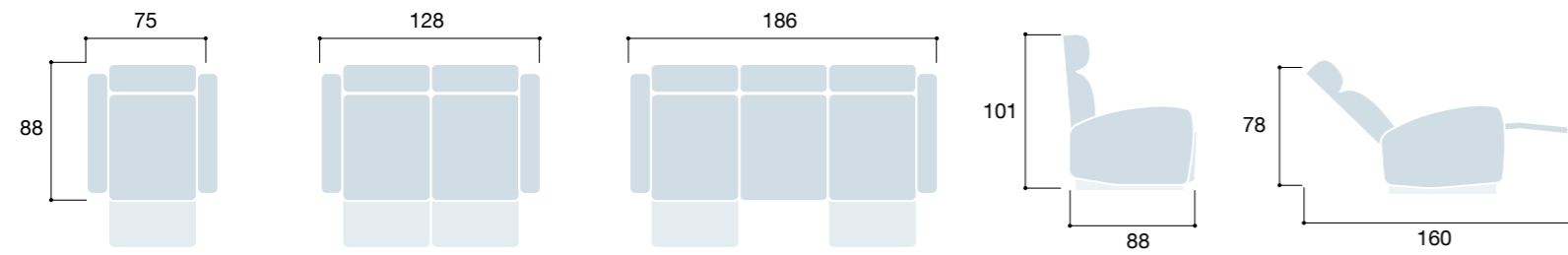

accionador manual



accionador eléctrico con cargador USB



## relax manual



**CG1628PI**  
Relax manual tapizado Pizarra 17

**PUNTOS 172**  
1 CAJA / PESO: 31,5 kg



**CG1634PI**  
Relax manual tapizado Pizarra 17

**PUNTOS 282**  
1 CAJA / PESO: 55 kg



**CG1638PI**  
Relax manual (sólo extremos) tapizado Pizarra 17

**PUNTOS 374**  
1 CAJA / PESO: 69 kg

## relax eléctrico



**CG1630PI**  
Relax eléctrico tapizado Pizarra 17

**PUNTOS 220**  
1 CAJA / PESO: 32 kg



**CG1636PI**  
Relax eléctrico tapizado Pizarra 17

**PUNTOS 378**  
1 CAJA / PESO: 57,5 kg



**CG1640PI**  
Relax eléctrico (sólo extremos) tapizado Pizarra 17

**PUNTOS 472**  
1 CAJA / PESO: 72 kg

## fijo



**CG1632PI**  
Fijo tapizado Pizarra 17

**PUNTOS 236**  
1 CAJA / PESO: 35 kg

bogal

salones

# Samurai



# Samurai

Muebles de comedor de chapa natural de roble con patas metálicas negras.



# Samurai



**CNG013NR**  
Módulo BAR 2 puertas de 80 con patas



PUNTOS	<b>374</b>
BULTOS	2
PESO TOTAL	58 kg



PUNTOS	<b>368</b>
BULTOS	2
PESO TOTAL	51,5 kg



**CNG015NR**  
Módulo TV 3 puertas 180 con patas



**CNG014NR**  
Módulo TV 2 puertas + 2 cajones 160



PUNTOS	<b>406</b>
BULTOS	2
PESO TOTAL	53,5 kg



PUNTOS	<b>280</b>
BULTOS	1
PESO TOTAL	42,3 kg



**CG1134NR**  
Módulo TV 2 puertas 120

# Pérsico rectangular

Mesa de comedor fija con sobre biselado de 19 mm de espesor acabado roble. Patas metálicas negras.



**CNG016NR**  
Mesa PÉRSICO 140 x 80

140 x 80

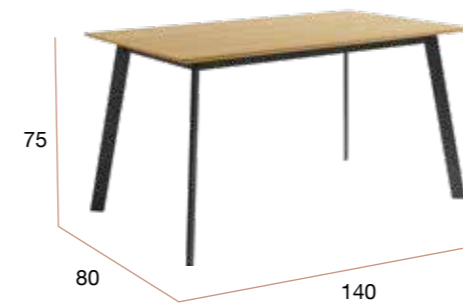

PUNTOS	264
BULTOS	2
PESO TOTAL	32,5 kg



**CNG017NR**  
Mesa PÉRSICO 160 x 90

160 x 90

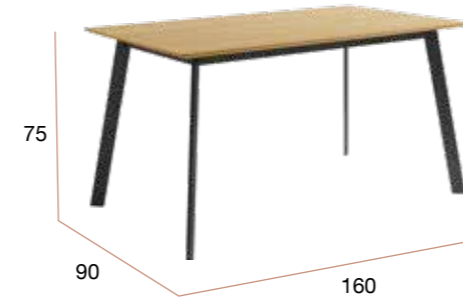

PUNTOS	280
BULTOS	2
PESO TOTAL	39,2 kg







# Java

juego de mesas cuadradas

Juego de mesas auxiliares cuadradas con patas metálicas negras y sobre biselado de 19 mm de espesor acabado roble.

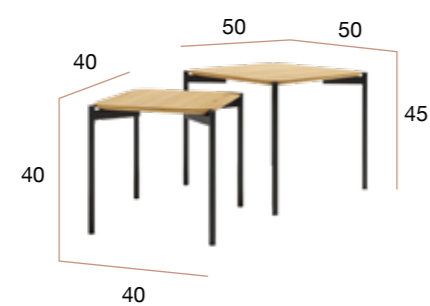

PUNTOS	<b>88</b>
MESAS POR CAJA	1 juego
PESO POR CAJA	8,2 kg



**CG1148NR**  
Juego mesas auxiliares  
JAVA cuadradas

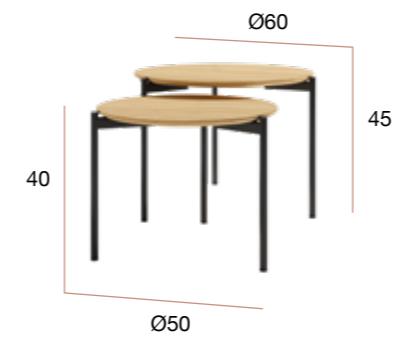

PUNTOS	<b>86</b>
MESAS POR CAJA	1 juego
PESO POR CAJA	8,9 kg



**CG1144NR**  
Juego mesas auxiliares  
JAVA redondas

# Java

juego de mesas redondas

Juego de mesas auxiliares redondas con patas metálicas negras y sobre biselado de 19 mm de espesor acabado roble.



# Java mesa cuadrada

Mesa de centro cuadrada con patas metálicas negras y sobre biselado de 80 x 80 cm y 19 mm de espesor acabado roble.

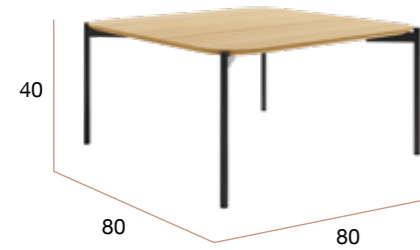

PUNTOS	100
MESAS POR CAJA	1
PESO POR CAJA	11,5 kg



**CG1146NR**  
Mesa de centro JAVA cuadrada 80 x 80



# Java mesa rectangular

Mesa de centro rectangular con patas metálicas negras y sobre biselado de 100 x 50 cm y 19 mm de espesor acabado roble.

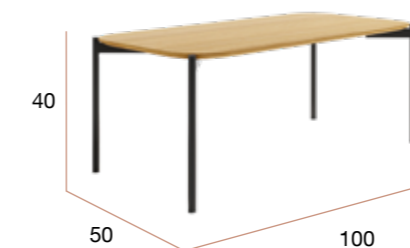

PUNTOS	86
MESAS POR CAJA	1
PESO POR CAJA	8,7 kg



**CG1150NR**  
Mesa de centro JAVA rectangular 100 X 50

bogal

literas



# Teruel

litera 90-90

Litera de dos camas de 90 x 190 construida en tubo metálico en dos acabados.

*La escalera y el quita-miedos se pueden montar a derecha o izquierda.*

PUNTOS	<b>176</b>
BULTOS	1
PESO POR CAJA	40,5 kg

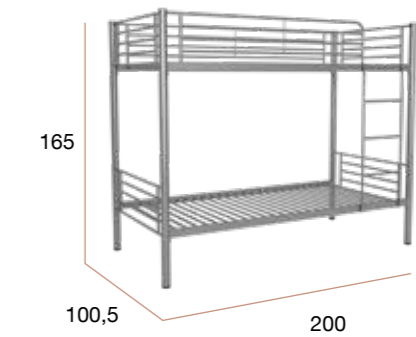

**CG1060BL**  
Litera TERUEL 90/90 x 190 blanca



**CG1060GS**  
Litera TERUEL 90/90 x 190 gris

# Bilbao litera 90-135

Litera familiar de 135 x 190 inferior y 90 x 190 superior. Construida en tubo metálico en dos acabados.

*La escalera y el quita-miedos se pueden montar a derecha o izquierda.*

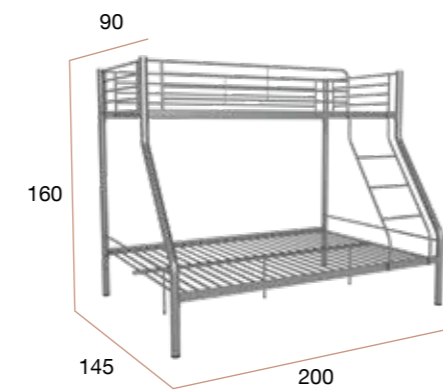

PUNTOS	184
BULTOS	1
PESO POR CAJA	42,8 kg



**CG1062BL**  
Litera BILBAO 90/135 x 190 blanca



**CG1062GS**  
Litera BILBAO 90/135 x 190 gris



bogal

bogal bogal bogal bogal

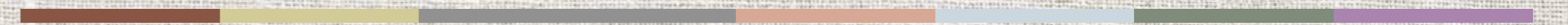

Edición y línea de producto:

bogal®

Imágenes:

bogal®

dirección creativa y producción gráfica:

bogal®

Debido a los sistemas de impresión, los soportes utilizados y la iluminación, los colores reproducidos en este catálogo pueden diferir de los colores reales del producto.

bogal® se reserva el derecho de introducir cualquier modificación en el diseño, medidas y puntos por razones técnicas o errores tipográficos.

Queda totalmente prohibida la reproducción total o parcial de este catálogo sin autorización de bogal®



Polígono Industrial "El Collet" - Ctra. Benicarló - San Mateo km 2.5  
Tel. +34 964 460 000 Fax +34 964 474 811 / +34 964 461 920  
info@bogal.es

[www.bogal.es](http://www.bogal.es)